

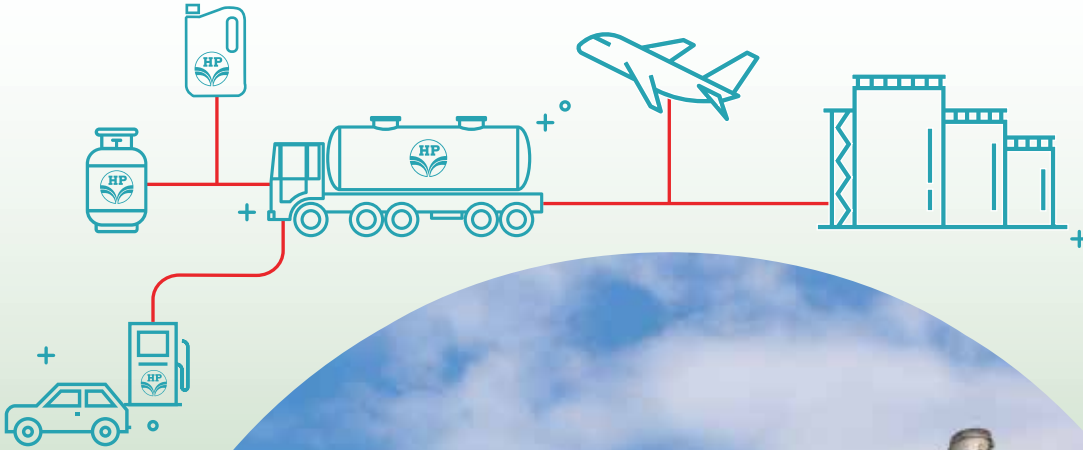

हिन्दुस्तान पेट्रोलियम कॉर्पोरेशन लिमिटेड
संधारणीयता रिपोर्ट 2019-20

Hindustan Petroleum Corporation Limited
Sustainability Report 2019-20





हिन्दुस्तान पेट्रोलियम कॉर्पोरेशन लिमिटेड
संश्लेषण रिपोर्ट 2019-20

Hindustan Petroleum Corporation Limited
Sustainability Report 2019-20



Sustainability is crucial to an organisation's existence, growth and continued success in dynamic times. Hindustan Petroleum Corporation Limited (HPCL) is well anchored on the triple bottom lines of people, planet and profit. We take pride in being an integral part of the daily lives of people by providing energy solutions to power dreams and fuel growth. With our specialised products and differentiated services that touch the lives of millions, we are continuously delivering happiness to the people. Our unwavering focus on this journey is realised through our unique and integrated business model. The images and illustration used on the cover depict the different sustainability focus areas interconnected and interspersed within HPCL.

Registered Office and Corporate Headquarters

Hindustan Petroleum Corporation Limited,
Petroleum House, 17, Jamshedji Tata Road,
Mumbai - 400 020, Maharashtra, India

Marketing Headquarters

Hindustan Petroleum Corporation Limited,
Hindustan Bhawan, 8, Shoorji Vallabhdas Marg,
Ballard Estate, Mumbai - 400 001, Maharashtra, India

Contents

- 2 About this Report
- 4 From C&MD's Desk
- 8 Message from Directors



10

About HPCL

- 14 Organisation Profile
- 22 Vision, Mission and Values
- 23 Corporate Governance
- 27 Internal Systems and Controls
- 30 Supply Chain
- 31 Memberships and Affiliations
- 32 Awards and Recognitions



36

Embedded Sustainability

- 39 Governance & Policies
- 40 Stakeholder Engagement
- 46 Materiality



48

Economic Performance

- 51 Financial Performance
- 52 Physical Performance
- 53 Strategic Planning Initiatives



76

People Performance

- 79 Team HP
- 81 Talent Acquisition
- 82 Enhancing Competencies
- 88 Performance Management
- 88 Motivation through Recognition
- 90 Employee Engagement
- 92 Employee Welfare
- 92 Human Rights
- 94 Safety at HPCL
- 99 Hale and Hearty HPCL
- 101 Asset Security



112

Corporate Social Responsibility

- 114 CSR Approach
- 115 Focus Areas
- 116 CSR Footprint



56

Environmental Performance

- 60 Materials Management
- 61 Energy Performance
- 64 Managing our Carbon Footprint
- 68 Renewable Energy Footprint
- 69 Water Management
- 72 Waste Management
- 74 Green Outlook
- 75 Driving Sustainability through Start-Ups



102

Delighting the Customer

- 105 Research & Development
- 108 Quality Assurance
- 109 Quality Control
- 110 Customer Focus

122

Alignment of our Business Practices to

- 122 Sustainable Development Goals
- 124 India's Nationally Determined Contributions
- 124 UNGC Principles

125 Independent Assurance Statement

128 GRI Content Index

133 Abbreviations

ABOUT THIS REPORT

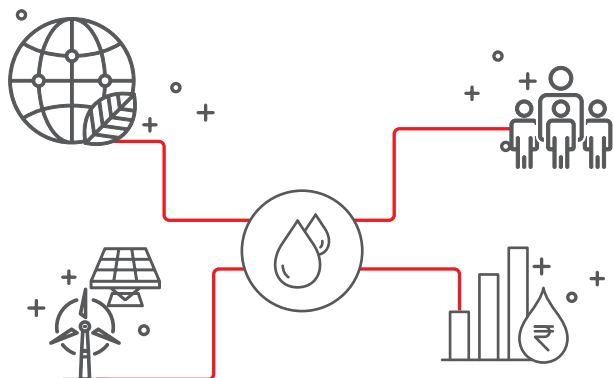

At Hindustan Petroleum Corporation Limited (HPCL), we take pride in being an integral part of the daily lives of people by providing energy solutions that power dreams and fuel growth. Be it the office goer, the fleet owner, the homemaker or the industrialist, we stand by them all to ensure that their growth momentum continues. Aligning ourselves with the agenda to mitigate climate change, we strive to fuel the nation's economy with a focus on reducing environmental impacts. No business can effectively operate in silos; it has numerous stakeholders directly or indirectly associated with it. By striving to conduct our business in a socially responsible manner, we empower lives, thereby delivering happiness to millions. **Led by innovation and steered by a sense of responsibility, we promise a 'Future Full of Energy' and are committed to 'Delivering Happiness'.**





↙
 An officer at work
 in one of our refineries

With a view to share our journey of growth and endeavours of sustainability with our stakeholders, we are proud to present our 9th Annual Sustainability Report. This Report covers our management approach, initiatives and performance on the economic, environmental and social aspects of the organisation's activities. It contains information pertaining to the period between April 1, 2019 and March 31, 2020. It has been developed in accordance with the comprehensive option of the Global Reporting Initiative (GRI) Standards, including the Oil and Gas Sector Supplement.

Our sustainability vision and initiatives are guided by and are aligned with both global and national priorities on sustainable development, that include the United Nations Global Compact (UNGC) Principles on Environment, Human Rights, Labour and Anti-corruption, United Nations' Sustainable Development Goals (SDGs) and India's Nationally Determined Contributions (NDCs). A detailed mapping of our contributions towards the realisation of these goals has been presented at the end of this Report.

The report boundary remains unchanged from our previous reports and encompasses all fully-owned operations of the Company. This includes our refineries at Mumbai and Visakhapatnam and the operations of the Strategic Business Units (SBUs) under marketing: Retail (Company-owned and Company-operated outlets only), LPG, Lubes, Direct Sales, Aviation, Natural Gas and Renewables, Operations and Distribution, Projects and Pipelines. This Report does not include joint ventures, subsidiaries and international operations.

The information contained in this report has undergone appropriate internal reviews and has been subjected to independent assurance by a third-party, M/s. Bureau Veritas India Pvt. Ltd. in accordance with the AccountAbility Assurance Standard AA1000 AS (2008) (With 2018 Addendum) Type 2 Moderate level.

The data presented in the Report has been either sourced from our Enterprise Resource Planning (ERP) system or directly from the operations included within the Report boundary. The data measurement techniques and underlying assumptions/calculations have been duly mentioned in the relevant sections of the report.

The most recent previous Sustainability Report for 2018-19 and all our previous Sustainability Reports are available at <https://www.hindustanpetroleum.com/CSRPolicies>.

Constructive feedback is necessary for bringing in new paradigms in the sustainable growth story and ensuring that our sustainability reports continue to disclose information material to our stakeholders. We welcome your queries or suggestions at: corporatehse@mail.hpcl.co.in or online on the HPCL website at: <https://hindustanpetroleum.com>

From C&MD's Desk



Amalgamating the principles of sustainability in our growth model, we strive to build a secure, sustainable and inclusive future for all our stakeholders

Dear Stakeholder,

As we have grown over the years to achieve the coveted 'Maharatna' status, we thank you for being with us through encouraging and challenging times. It gives me great pleasure to present to you the 9th Sustainability Report of Hindustan Petroleum Corporation Limited for 2019-20. This report presents our efforts towards continually building a sustainable business while upholding our commitment to Environment and Social Sustainability. Every living being, which endeavours to reach the farthest mile, takes time and effort to prepare itself for the same. HPCL, too, over the decades has undertaken many great strides to further its scale and reach with a single minded focus on positively impacting the lives of millions of its stakeholders and fuelling prosperity for our nation. More so, the previous few years have witnessed numerous far-reaching changes undertaken by our competitive team of HPites to bring forward a future ready organisation. As you go through this report, I am sure you will witness the determined efforts of Team HPCL as we stand fast to our commitment of 'Delivering Happiness'.

The concept of sustainability describes a condition in which human growth and development, required for the continuation of life, is in balance with the earth's natural ability to replenish natural resources and is aptly termed 'the triple bottom line'.

Sustainability at HPCL is about delivering happiness to its stakeholders. It is about changing the paradigm of how HPCL operates its business and understands the expectations of its stakeholders. HPCL has remained responsive to the needs of its customers while creating healthy ecosystems and vibrant communities. HPCL is aware that stakeholders have varied expectations that extend beyond financial goals and legal requirements. In this regard, HPCL has consistently made efforts to integrate sustainability within the operations to create long-lasting value for all.

The operating context of the oil industry has changed considerably in recent years. Global geo-political situations, supply demand disparities, stringent quality specifications in light of stricter environmental regulations as well as increasing demands of

combustion technologies, incorporation of aspects related to climate change into our operations, crude oil purchase price and product selling price volatilities, advent of Electric Vehicles and other disruptive technologies, increased complexity of manufacturing processes etc. pose multidimensional risks. We continuously aim to adapt and mitigate such probable risks through business portfolio diversification, technological upgradation, operational excellence, focussing on carbon intensity reduction, unflinching ethical standards and safety performance. Amalgamating the principles of sustainability in our growth model, we strive to build a secure, sustainable and inclusive future for all our stakeholders.

To stay ahead of the performance curve, HPCL formulated the 'T20 strategy' with a clearly defined roadmap, having safety and integrity at the heart of all actions. This helped us realise our Vision and Mission and navigate the future business landscape by enhancing performance across the triple bottom line indicators of planet, people and profits.



Economic Performance

During the year, HPCL registered gross sales of ₹ 2,86,250 Crore and a Profit after Tax of ₹ 2,637 Crore.

Financial Year 2019-20, especially the last quarter, saw unprecedented event like outbreak of COVID-19 pandemic leading to global and nationwide lock downs and demand contraction on the back of generally sluggish global economic activities. This, coupled with the inability of oil producing countries to reach a consensus to rebalance the supply demand situation, led to unforeseen volatility in crude oil and product prices. Surplus inventories, lower demand, geo political situations led to one of the steepest falls in crude oil prices seen in the last two decades. The nationwide lock down to contain the spread of the pandemic in India led to substantial demand contraction in the last part of March 2020.

During these challenging times, HPCL continued its operations to ensure availability of products and services to the general public and for essential services while ensuring the safety and wellbeing of its stakeholders and the workforce.

During 2019-20, our refineries at Mumbai and Visakhapatnam achieved combined refining throughput of 17.18 Million Metric Tonnes (MMT) with capacity utilisation of 109%.

HPCL continued to deliver strong sales performance with consistent thrust on competitive marketing strategies, optimal resource utilisation, cost optimisation and innovative practices. During 2019-20, HPCL achieved

39.64 MMT

Highest ever sales volume achieved in 2019-20

the highest ever sales volume of 39.64 MMT compared to previous year's sales of 38.7 MMT.



Environmental Performance

Everything that we need for our wellbeing depends, either directly or indirectly, on our natural environment. HPCL is aware of the importance of reducing its impact on the environment while striving to enrich it.

HPCL is adopting best-in-class operating systems, practices and procedures for achieving environmental sustainability. Both our refineries and major installations are certified with Environmental Management Systems. Effluent treatment plants, air emission control and hazardous waste management systems have been installed at various locations for monitoring, in line with the best practices.

HPCL has upgraded its refineries and aligned the entire value chain for producing and marketing BS-VI fuels. While the BS-IV fuels contained 50 parts per million (ppm) sulphur, the BS-VI grade fuel has only 10 ppm sulphur content, which will lead to reduction in emissions.

HPCL has launched IMO-2020 compliant Very Low Sulphur Fuel Oil (VLSFO) meeting Residual Marine Grade (RMG) 0.50 Specification and ISO 8217:2017 Standard requirements. This fuel also meets all quality guidelines detailed by the International Organisation for Standardisation in its ISO 23263:2019 Standard.

With a focus on energy efficiency, both our refineries are actively participating in energy conservation programmes like the PAT Cycle II (Perform, Achieve and Trade) of the Bureau of Energy Efficiency (BEE). The measures undertaken by HPCL's refineries during 2019-20 resulted in savings of about 25,586 SRFT (Standard Refinery Fuel Tonnage).

HPCL has upgraded its refineries and aligned the entire value chain for producing and marketing BS-VI fuels

From C&MD's Desk

Majority of the product evacuation through refineries and movement to interior geographies takes place through pipelines, helping in safer product movement while optimising logistics costs and reducing carbon footprint. HPCL clocked a pipeline throughput of 21.2 MMT in 2019-20. During the year, we completed four pipeline projects and expanded the pipeline network to 3,775 km from 3,370 km. To help reduce carbon intensity of the transportation sector, HPCL is actively participating in the biofuel blending programme. HPCL procured 46 Crore litre of Ethanol, which resulted in an overall Ethanol Blending Percentage of 4.96%. In addition, HPCL recorded the blending of highest ever quantity (5 Crore Litre) of biodiesel during 2019-20.

3,775 km

Pipeline Network

During 2019-20, HPCL along with its JVs actively pursued clean fuel segments such as City Gas Distribution (CGD) networks, LNG Regasification facilities at Chhara port in Gujarat as well as setting up of compressed biogas plants.

HPCL has a total wind power and solar power installed capacity of 101 MW and 32.6 MWp respectively as of March 31, 2020, which contribute to carbon footprint reduction. Further, Green belt development programmes have been implemented at various locations to aid in carbon sequestration and biodiversity improvement. HPCL has a green cover of over 1,150 acres inside premises as on March 31, 2020. These plantation areas have variety of native and adaptive species of trees and shrubs which form local micro eco-systems, attracting numerous species of domestic and migratory fauna.

HPCL is focused on promoting the Start-up ecosystem for nurturing Start-ups and entrepreneurs in the Oil & Gas sector in collaboration with other business entities on fuel and non-fuel businesses etc. HPCL is supporting Start-ups, which are working in the field of promoting environmental sustainability. Few of the initiatives are harvesting solar energy for household cooking, aggregation and utilisation of surplus biomass, reducing plastic pollution, 2G bioethanol from agricultural biomass as well as development of EV ecosystem in India.

HPCL has a total wind power and solar power installed capacity of 101 MW and 32.6 MWp respectively



Social Performance

HPCL has continued to undertake numerous initiatives for acquiring and retaining talent. During 2019-20, HPCL has been able to deliver consistent performance due to a highly motivated workforce of 9,696 employees across refining and marketing locations and the unstinted support of our various stakeholders. A number of employee engagement initiatives were deployed to increase cohesion between the Company, the employee and the employee's family. HPCL believes that a diverse workforce adds significant value to the Company and hence we embrace diversity and inclusion. HPCL is committed to comply with the provisions of the Persons with Disabilities (RPWD) Act, 2016. This year, we have adopted an 'equal opportunity policy' consistent with maintaining an environment that is based on merit and inclusiveness. We have laid special emphasis on preventive and curative measures for the health of our employees and extended workforce, and even more so in the challenging COVID-19 times.

A host of technical and behavioural programmes for employees and the extended workforce have been pioneered for effective capability building and sensitisation. To ensure emergency preparedness, Emergency Response Disaster Management Plant (ERDMPs), Crisis Management Plans (CMPs) are maintained and mock drills are regularly conducted at locations to keep everyone in a state of readiness.

HPCL is fully supporting the Pradhan Mantri Ujjwala Yojana (PMUY), which aims to provide clean cooking fuel solution to poor households, especially in rural areas. We along with other PSU OMCs achieved the target of 8 Crore PMUY connections in September 2019 way ahead of the target date of March 31, 2020. A total of 2.15 Crore PMUY LPG connections were released by HPCL.

HPCL surpassed the MSE procurement level of 25% specified in Government of India guidelines by registering 30.47% procurement from Micro and Small Enterprises (MSEs) in 2019-20. HPCL has also been fully abiding by the policy related to boost the local content under the 'Make in India' initiative.

30.47%

Procurement from MSEs

Through its CSR initiatives, HPCL enriched the lives of thousands of underserved people with an overall spending ₹182.24 Crore in 2019-20. These initiatives are undertaken in the focus areas of childcare, education, healthcare, skill development, sports, environment and community development. Under Swachh Bharat

Abhiyan, HPCL undertook construction / upgrades of over 1,000 new toilets in various schools and communities across the country.

As a responsible Corporate citizen, HPCL has contributed ₹ 120 Crore to 'PM Cares' fund to help India combat the COVID-19 pandemic. In addition, HPCL and its Channel partners have voluntarily provided food, water, masks, sanitisation kits etc. to stranded migrant workers on highways and workers at project sites.



Recognitions

For outstanding performance across various spheres of business, HPCL was recognised with several prestigious International and National awards during the year.

- HPCL was conferred with “Best Navratna” award in Manufacturing Sector category by M/s. Dun & Bradstreet for the second year in a row
- “Company of the Year for Excellence in Human Resource Management” award by Federation of Indian Petroleum Industry (FIPI)
- National Corporate Social Responsibility (CSR) Award under the category ‘Contribution to National Priority Areas: Education’ by Government

As HPCL, in tandem with our great nation, transcends one horizon after another, we foresee a future full of energy, energy which is key to enabling the aspiring masses to achieve their dreams

of India and Honourable Mention in the category ‘Contribution to National Priority Areas: Support to Differently Aabled’ for Project ADAPT

As HPCL, in tandem with our great nation, transcends one horizon after another, we foresee a future full of energy, energy which is key to enabling the aspiring masses to achieve their dreams. As we set foot into newer domains and ramp up our existing businesses, we will continue to live by the ethos and principles of responsible business practices for fostering a sustainable future. We appreciate the unstinted support of our stakeholders in our endeavour and look forward for many more milestones together.

Thank you

MUKESH KUMAR SURANA
Chairman and Managing Director



7
Hon'ble Home Minister of India, Shri Amit Shah, presenting Rajbhasha Kirti Award to C&MD, Shri M. K. Surana

Message from Directors

PUSHP KUMAR JOSHI

Director - Human Resources



Our commitment to 'Deliver Happiness' is an integral part of our philosophy. As a responsible corporate citizen, we believe in empowering and enhancing the quality of lives of people by meeting the requirements of their energy landscape. Our employees are the most valuable asset in fulfilling the commitments of our stakeholders. For creating a sustainable people-centric ecosystem, we live by the values of 'HP FIRST' that fosters a performance-oriented culture and provides equal opportunities. We focus on the development of our employees at both professional and personal levels, inculcating a culture of self-motivated learning that inspires them to excel in the areas of people, planet, prosperity, peace and partnership. We continue to support the core principles of United Nations Global Compact. Our community initiatives complement the national developmental initiatives to positively impact the underprivileged and marginalised sections of the society.

R. KESAVAN

Director - Finance



As the world faces new challenges, it is paramount to effectively mitigate the business risks to ensure sustainability and investment outcomes. Robust economic performance is a key driver and important pillar of sustainable development. We have crafted a unified risk management framework and operating processes for enhanced synergistic resilience of economic, ecological and social capital. Sustainability of business and growth of its stakeholders is intertwined, and one cannot succeed at the cost of the other. It is our belief that businesses can continuously evolve for transformative contribution towards attainment of sustainable development objectives on larger scales through sustained focus on governance and deliverance of greater good for all stakeholders. In this spirit, we have been continuously enhancing and delivering value in our business and remain ever committed to do so.

VINOD S. SHENOY
Director - Refineries



HPCL Refineries are committed to meet the energy needs of our nation while maintaining a strong focus on environmentally sound and robust practices. We believe in an integrated approach built on operational and environmental excellence, ensuring health and safety while delivering quality products to our customers. This year marked a quantum leap in terms of commitment towards environment through capacity and quality upgradation investments in large-scale projects at our Refineries, thereby switching over to BS-VI compliant fuels. Our green R&D centre has been leveraging technology for innovation and has been supporting Refineries and Marketing SBU with new generation products. The Refineries are continuously investing in plant hardware, process improvements and people competencies and are committed to deliver safe, superior and sustainable performance.

RAKESH MISRI
Director - Marketing



We strive continuously to create positive impact on the lives of wider sections of the society and our stakeholders. We understand that the world is undergoing a rapid transformation and so are the stakeholders' expectations. With an unwavering focus on customers, we have been continuously improvising our products and service standards in pursuit of excellence. Our business processes enable innovation and competitive growth while enriching the environment and creating positive impact. We are focussing on increased digitalisation of our processes to bring in more efficiency, safety and superior experience to our customers. This year, we have demonstrated stellar performance and achieved the highest ever sales volume of 39.64 MMT, delivering happiness across nooks and corners. We believe in carrying out business in ways that are socially relevant, environmentally conscious and ethically sound.

ABOUT HPCL

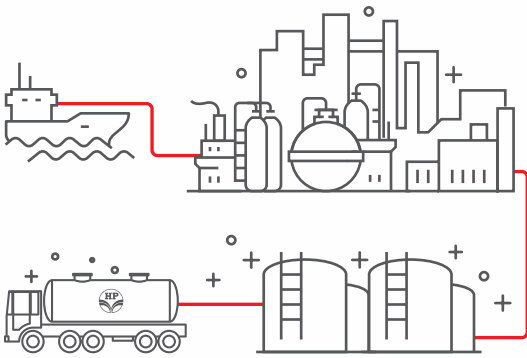

- 14 Organisation Profile
- 22 Vision, Mission and Values
- 23 Corporate Governance
- 27 Internal Systems and Controls
- 30 Supply Chain
- 31 Memberships and Affiliations
- 32 Awards and Recognitions



A view of one of our LPG plants ↗



About HPCL

POWERING INDIA'S ENERGY NEEDS

HPCL achieved the coveted Maharatna status in 2019-20, and has a proud legacy and heritage of over four decades. We continue to add value to the nation as one of the largest public-sector enterprises under the Ministry of Petroleum and Natural Gas, Government of India. HPCL ranked 73rd and 71st by market capitalisation as on March 31, 2020 at the Bombay Stock Exchange and the National Stock Exchange, respectively. We have a strong presence in the petroleum refining and marketing sector with a market share of ~21% among the Indian public sector Oil Marketing Companies (OMCs) as on March 31, 2020.



Corporate Headquarters - Petroleum House

HPCL refineries at Mumbai and Visakhapatnam refine crude oil into several value-added products, including over 300 grades of lubricants, specialties and greases. We have held our status as the largest producer of base oils in the country. In addition, we source our product requirements from 11.3 MMTPA capacity Guru Gobind Singh Refinery at Bathinda, which is a joint venture between HPCL and Mittal Energy Investments Pte. Ltd., Singapore with equity holding of 48.99% each. We also hold an equity of 16.96% in the 14.14 MMTPA Mangalore Refinery and Petrochemicals Ltd. (MRPL).

HPCL is currently operating a petroleum product pipeline network of 3,775 km with mainline capacity of 32.55 MMTPA and branch line capacity of 15.57 MMTPA. Our pan-India marketing network comprises 133 regional offices. This network is supported by a supply and distribution infrastructure comprising Terminals, Pipeline Networks, Aviation Service Facilities, LPG Bottling Plants, Inland Relay Depots, Lube Plants, Retail Outlets, SKO/LDO Dealerships, Lube and LPG Distributorships.

Our green R&D Centre at Bengaluru provides impetus to our research capabilities by creating innovative and path-breaking technologies and products within the energy sector. Over the years, it has developed and patented several novel technologies and upgraded the existing ones to achieve greater efficiency and build indigenous capabilities.

Our Lube R&D at Vashi, Navi Mumbai, continues to play a proactive role with developments of new products for government and private sector customers. It focuses on ensuring that HP Lubricants consistently meet stringent national and international standards. It also shares quality information through presentations, publications (national and international journals), seminars and conferences to the industry.

An Overview of our Infrastructure



2

Refineries



2

LPG Import Locations

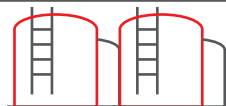

43

Terminals and TOPs

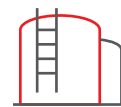

41

Inland Relay Depots



50

LPG Bottling Plants

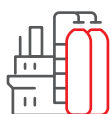

6

Lube Blending Plants



44

Aviation Service Facilities



6

Pipelines (Main Lines - POL)



4

Pipelines (Branch Lines - POL)



2

Pipelines (Main Line - LPG)



2

Specialty Product Pipeline (Lube Oil/ATF)



27

Exclusive Lube Depots (COLD/COD)



16,476

Retail Outlets



6,110

LPG Distributorships



1,638

SKO/ LDO Dealerships



186

Auto LPG Dispensing Stations (ALDS)



471

Retail Outlets with CNG Facilities



115

Clearing and Forwarding Agents (CFA)



260

Lube Distributors

About HPCL

ORGANISATION PROFILE

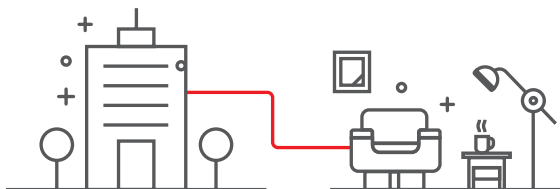

Our inspiration lies in knowing that we add value to the latent rich resources of crude petroleum and aid the growth and development of our nation by providing vital energy solutions. Since the onset of our journey in the energy business right from incorporation to expansion, public listing and consolidation of strengths in the ever changing energy scenario, we have acted on our conviction that energy empowers people and communities and steers the country towards a better future. We have become synonymous with energy and we strive to build a world-class company that is known for quality products, innovative services, customer centricity, safety norms, employee relations and welfare. We have ventured into new avenues of business. Our portfolio comprises two major refineries with excellent infrastructure, producing a variety of petroleum products and wielding a vast marketing network across the country. We have also pioneered numerous customer focused initiatives and services with technological upgradation and process digitisation.



7
Hon'ble Minister for Petroleum & Natural Gas and Steel, Shri Dharmendra Pradhan, dedicating VVSPL capacity expansion project to the Nation

Refineries



Our two refineries, located at Mumbai and Visakhapatnam, focus on achieving maximum operational efficiency and producing quality products by implementing modernisation projects. The capacities of the Mumbai Refinery and Visakh Refinery are 7.5 and 8.33 MMTPA respectively. Mumbai Refinery is a Lube based refinery with the highest lube production capacity in India.

Major Products

Light Distillates



Liquefied Petroleum Gas
Motor Spirit
Naphtha
Hexane
Propylene
Solvent 1425

Middle Distillates



High Speed Diesel
Superior Kerosene Oil
Light Diesel Oil
Aviation Turbine Fuel
Mineral Turpentine Oil
JBO

Heavy Distillates



Bitumen
Furnace Oil
Low Sulphur Heavy Stock
Others

Capacity utilisation at HPCL Refineries at Mumbai and Visakhapatnam during the year was higher than their installed capacities during the year in spite of numerous challenges, including rollout of BS - VI grade fuels and volatile crude and product prices affecting GRMs. Achieved combined throughput of 17.18 MMT registering a capacity utilisation of 108.7 %.

In line with our commitment towards environment protection, we have undertaken several revamping activities across both the refineries for compliance with BS-VI regulations. In addition, capacity expansion projects were undertaken to increase Mumbai Refinery capacity from 7.5 to 9.5 MMTPA and Visakh Refinery capacity from 8.33 to 15 MMTPA, along with state-of-the-art complexity enhancements, including bottom upgradation facilities.

2019-20 Highlights

Mumbai Refinery

- Achieved throughput of more than 8.0 MMT for the 5th consecutive year
- Rolled out BS-VI MS and HSD fuels before the timeframe stipulated by the Government of India
- Attained highest ever LOBS throughput of 478.1 TMT
- Completed highest ever landmark in safety i.e. 27.52 million safe man-hours of operation
- Carried out trials of Dewaxing Aid and Diesel Lubricity additive chemicals developed by HP Green R&D Centre (HPGRDC)
- Installed and commissioned a wireless vibration monitoring system for 12 nos. critical rotary equipment to monitor live tracking of vibration readings
- Completed M/s. Solomon Associates (SA) benchmarking exercise of CY 2018
- Displayed progressive improvement in Energy Intensity Index (EII) over last four bi-annual cycles
- Achieved improvement in EII from 117 to 105.3

Visakh Refinery

- Achieved throughput of more than 9.0 MMT for the 5th consecutive year
- Rolled out BS-VI MS and HSD fuels before the timeframe stipulated by the Government of India
- Started production of VLSFO (Very Low Sulphur Fuel Oil) with less than 0.5% Sulphur content, meeting regulatory requirement of International Convention for the Prevention of Pollution from Ships (MARPOL)
- Conducted trials of HP - Thermopro, an anti-foulant for heat exchangers
- Processed WTI midland crude from USA for the first time
- Commissioned the integration project of ARUs in Merox and MS blocks
- Completed M/s. Solomon Associates benchmarking exercise of CY 2018
- Displayed progressive improvement in EII over last four bi-annual cycles
- Demonstrated improvement in EII from 116 to 104.9

About HPCL

Marketing



7
Commissioned our first retail outlet in Bhutan

Our product offerings cater to a large and diverse customer base across the domestic, automotive, commercial and industrial segments. Our business verticals include Retail, LPG, Lubes, Direct Sales, Aviation, Natural Gas and Renewables, Operations and Distribution, Projects and Pipelines.

Continuing the growth momentum demonstrated in the previous years, we recorded stellar performance across the business verticals of marketing. During the reporting year, we achieved the highest ever sales volume of 39.64 MMT as against the sales volume of 38.7 MMT in 2018-19.

In domestic sales, we recorded a sales volume of 37.74 Million Tonnes during 2019-20 against a sales volume of 37.97 Million Tonnes in 2018-19 and a market share of ~21% among the public-sector Oil Marketing Companies (OMCs).



Retail

Retail sales form a major part of our total revenue. Our nationwide network of retail outlets caters to customers' fuel needs and provides complete vehicle care services through our 'Club HP' and 'Club HP Star' outlets. Consumer convenience and benefits come with purchasing our products through cashless transactions and loyalty programmes.

2019-20 Highlights

- Achieved sales volume of 24.4 MMT, crossing the 24 MMT mark for the second time in a row
- Commissioned 1,194 outlets during the year
- Achieved 100% automation of all operating/active retail outlets, attaining new industry benchmark of 94.8% of 'No Automation No Operation' (NANO) at the automated outlets
- Commissioned CNG facilities at 166 retail outlets

- Increased door-to-door delivery facility for diesel to 18 cities/towns
- Commissioned first retail outlet in Bhutan, in partnership with State Trading Corporation of Bhutan (STCBL), a Government of Bhutan entity
- Implemented several commercial initiatives, resulting in process efficiency, better monitoring, reduced costs and benefits to dealers
- Installed solar power panels at 1,050 retail outlets
- Increased the number of EV charging facilities at retail outlets with few using a renewable form of energy through Solar PV
- Installed Stage I vapour recovery systems at all outlets and Stage II vapour recovery systems at 525 outlets in NCR
- Launched several digital initiatives during the year, such as Retail Sales Analytic Dashboard, Integrated Payment System with integration of point-of-sale machine with dispensing units, digitalised retail policy manual, and a social media profile with the handle 'Mera HP Pump'
- Achieved DriveTrack Plus sales volume growth of 2% YoY as a result of successful tie-ups with OEMs and focused enrolment of low-volume customers
- Surpassed MoU target of 32% by achieving 32.6% digital conversion at Retail Outlets during March 2020
- Launched 'HP Pay' mobile app. This unified app is an 'industry first', facilitating purchase of various products of HPCL viz., Motor Fuels, domestic LPG and Lubricant Oil, giving wider choices and options of payments to customers
- Enabled acceptance of FASTag as payment option at our retail outlets

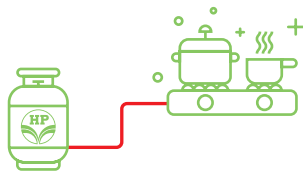

LPG

LPG is one of the very first products with which millions of citizens start their day. HP Gas, our brand of LPG, ensures that our consumers enjoy the warmth and happiness that cooking brings, daily, safely, without an interruption. HP Gas has played a key role in reaching clean and efficient cooking fuel to the farthest corners of rural populace. HP Gas continues to provide clean energy solutions to commercial establishments and industries through marketing of LPG cylinders and bulk LPG supplies through tankers.

2019-20 Highlights

- Achieved highest ever LPG sales of 7 MMT, registering a growth of 7.3%
- Commissioned 50th LPG Bottling Plant at Sugauli in Bihar
- Launched smaller capacity (2 kg) cylinder in Free Trade LPG (FTL) category under 'APPU' brand of HPGAS to meet the demand of small vendors and young professionals
- Commissioned 245 LPG distributorships during the year
- Enrolled 37.53 Lakh new customers, including 19.56 Lakh connections under Pradhan Mantri Ujjwala Yojana (PMUY)
- Enrolled 2.15 Crore beneficiaries as part of the ongoing PMUY scheme. HPCL along with other OMCs, successfully accomplished the target of providing 8 Crore LPG connections to families under the scheme ahead of the slated date
- Conducted 10,824 Pradhan Mantri LPG Panchayats
- Achieved productivity of 1,610 cylinders/hour from own plants
- Coordinated with Start-ups for improvisation in processes and customer safety using latest technologies
- Operationalised all four owned rakes, resulting in substantial logistics savings
- Surpassed MoU target of 3% by achieving 6.7% digital transaction of total domestic refill sales during March 2020
- Surpassed MoU target of 80% by achieving 4 and 5 target delivery time (TDT) rating in 88.2% LPG distributorships
- Commissioned new carousels at Jatni, Kondapally, Hoshiarpur, Anantpur, Raipur and Manglia plants
- Launched WhatsApp and Bharat Bill Pay (BBPS) services for facilitating online refill booking and payment for LPG consumers, HP Gas Vitran App for digitisation of distributorship delivery activities and Intelligent Inventory Management system & QR code based asset management systems to streamline plant operations

About HPCL

Lubes

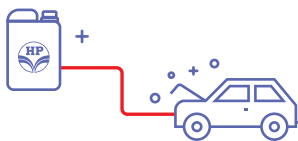

HP Lubricants, India's largest lubricant marketer, holistically caters to lubricants, specialties and greases requirements, manufactured in state-of-the-art blending plants spread across India. The grades manufactured by HP Lubricants finds application in automotive, industrial, mining and construction, agriculture, fishing, defence and railways among others. HP Lubricants is supported by a robust marketing network that spreads across the country through warehouses, distributors, CFAs and offices with highly qualified sales and technical personnel.

manufacturers and executed corporate tie-ups with several OEMs

- Commissioned Smart Manufacturing Monitoring system at Mazgaon terminal, first among PSUs

2019-20 Highlights

- Maintained the position of largest Lube marketer in the country for the 7th year in a row and achieved overall sales volume of 650 TMT
- Achieved highest ever sales of value-added lubes of 518 TMT representing a growth of 6%
- Achieved highest ever export of 16.7 TMT of HP Lubricants, making us the largest exporter of lubricants among PSUs
- Became the first OMC to commercially produce and sell Diesel Exhaust Fluid (DEF) - a speciality product mandatorily used in BS-VI compliant diesel engines
- Developed mobile app 'HP Lube Oil Sahayak', which helps customers identify the recommended lube grade for their vehicles based on brand and model of vehicle
- Commissioned 25 new channel partners, appointed distributors for international markets
- Launched wide range of Lubricants and Specialty Fluids to meet the requirements of BS-VI compliant engines, hybrid and electric vehicles
- Launched 70+ new packages/SKUs for domestic and export market
- Implemented various sustainable packaging initiatives during the year, such as in-house carton printing, dual language package printing for international markets, designing of palletisation matrix, trials of monolayer racer pouch, trials with recycled HDPE plastic for HDPE container
- Conducted 500+ market and customer connect activities
- Obtained approvals from various prestigious national, international agencies and

Direct Sales (Industrial and Consumer)

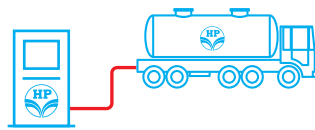

HPCL's Industrial & Consumer (I&C) business-line handles the institutional sales of fuels, bitumen, naphtha and other bulk products consumed by industries, mining, road construction, infrastructure projects, power plants, shipping, chemicals and petrochemicals etc. in both private and government sectors and also carries out exports of these products to various overseas markets.

2019-20 Highlights

- Achieved overall sales volume of 5 MMT
- Exceeded 1 MMT in Furnace Oil (FO), HSD, Bitumen individually for the 5th consecutive year and achieved highest ever sales volumes in LDO, MTO and LSHS
- Introduced VLSFO (very low Sulphur fuel oil) to leverage the opportunities emerging from implementation of IMO 2020
- Commenced sales of Branded MTO-'HP Shine' in barrels for paints and allied industry
- Signed MoU with Border Roads Organisation (BRO) and Paramilitary Forces and obtained Rate Contract for supplies to Indian Railways and Army of various products like HSD, Bitumen, SKO, etc.
- Rolled out service and sales modules of Customer Relationship Management (CRM) enterprise application
- Launched Bitumen Invoice Verification portal for PWD Customers



Aircraft refuelling by one of our Aviation service facility

Aviation

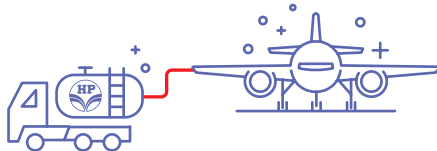

HP Aviation provides Aviation Turbine Fuel (ATF) refuelling services at various airports across the country. We have been associated with several domestic and international airlines. HP Aviation continues to expand its footprint to meet the growing demand of Jet fuel at newer airports. Our Jet fuel refuelling service facility, we aptly call it 'Aviation Service Facility' (ASF), meets and exceeds stringent International regulations for handling Jet fuel. We stand steadfast in our commitment to quality: 'Quality Fuel in the Aircraft, Safely on Time, through process aimed at enhancing Customer Delight'. HP Aviation's strength is its committed manpower providing quality service encompassing all areas of operations and delivering quality product and service.

2019-20 Highlights

- Achieved sales volume of 732 TMT
- Commissioned new ASFs at Nagpur and Ranchi
- Augmented Aviation supply chain for Kolkata ASF by adding Rake Unloading facility at Budge Budge Terminal
- Refueled flights at Kolhapur, Belgaum and Sangli during flood relief operations at Kolhapur, North Karnataka districts during August 2019
- Conducted customer meets at Kolkata, Chennai and Mumbai
- New customer portal based on latest CRM software was made online for addressing customer queries, feedback and suggestions
- Developed XML data transfer protocol in collaboration with Air India to improve data handling at the airline side

Natural Gas and Renewables

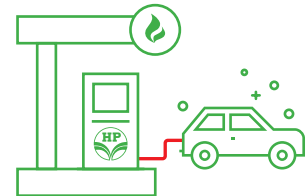

HPCL is aligned with the nation's agenda of achieving growth by adopting a low carbon path. We took on initiatives to strengthen our presence within the natural gas sector. With a focus on the entire value chain, we are working to establish ourselves from sourcing LNG from international market, building of regasification terminal, laying of cross-country gas pipelines to marketing of gas to consumers. We are leveraging wind and solar energy sources to reduce our carbon footprint across the value chain and continuously expanding the renewable power generation capacities.

2019-20 Highlights

- Provided CNG facilities at 166 retail outlets, bringing the number of retail outlets with CNG facilities to 471
- Signed Gas Sales Transmission Agreement, Gas Facilitation Agreement for gas offtake in Jind- Sonipat Geographical Area and in five other geographical areas under UP cluster
- Facilitated Mumbai Refinery by strategising their gas sourcing options, which enabled the Refinery to achieve substantial cost savings
- Released LOI to set up 40 new CBG plants with a capacity of 55 TMTPA, taking cumulative to 51 LOIs with capacity of 76 TMTPA
- Secured gas allocation from MoPNG to cater to CNG for automobile sector and domestic PNG in nine geographical areas across 20 districts
- Installed captive solar power capacity of ~10 MWp across various locations, taking total solar power capacity to 32.6 MWp
- Total of 100.90 MW wind power capacity generated ~18.6 Crore kWh electricity
- Started selling Renewable Energy Certificates (RECs) in the Indian energy exchange
- Commenced open access electricity purchase for marketing locations and refineries to optimise electricity cost

About HPCL

Operations and Distribution



The Operations and Distribution (O&D) vertical is the bedrock of HPCL's supply chain. It handles product movement and distribution with assured quality, quantity and safety, ensuring adequate product availability to customers at all times. We keep on upgrading our terminals and depots with the latest technologies to enhance operational efficiencies and keep pace with increasing and evolving customer demands.

2019-20 Highlights

- Achieved an all time high throughput of 53.2 MMT
- Completed the migration of all POL locations to BS-VI norms within timelines through meticulous planning and timely execution
- Ensured supply of petroleum products in times of adversity, such as natural calamity, refinery production variations and the recent outbreak of COVID-19 across India
- Recorded the lowest ever tank truck cycle time of 41 minutes (all India average)
- Achieved significant productivity improvements by enhancing bay filling rates
- Increased proportion of higher capacity tank trucks in fleet, leading to transportation cost savings and reduced carbon footprint
- Recorded blending of highest ever quantity (5 Crore litre) of biodiesel
- Leveraged several supply chain optimisation measures at locations throughout the country, leading to substantial cost savings
- Completed Installation of vapour recovery units (VRU) at five locations in NCR and initiated installation of VRU in 20 other HPCL supply locations across India in a phased manner
- Made further enhancements to the implementation of electromechanical locking system at additional POL locations
- Implemented several digital initiatives for better planning and transparency in the supply chain

Project and Pipelines

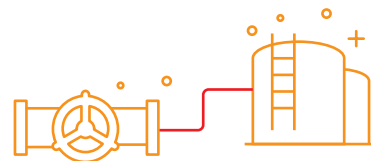

Pipelines ease the overburdened Rail and Road infrastructure and minimise environmental impacts arising out of Rail and Road transportation. Pipelines play a significant role in meeting the demand of petroleum products in India. We operate a pipeline infrastructure of 3,775 km with a mainline capacity of 32.55 MMTPA and a branch line capacity of 15.57 MMTPA. We have undertaken major projects to scale up the infrastructure for augmentation and expansion of our pipeline network and increasing the safety and reliability of pipeline operations. We achieved all government MoU milestones for pipeline projects within time and the ongoing pipeline projects were ahead of schedule.

Major Completed Projects

- Commissioned Mundra Delhi Pipeline (MDPL) Capacity Expansion and Palanpur Vadodara Pipeline (PVPL) Project ahead of schedule with substantial cost saving
- Commissioned Visakh Vijaywada Secunderabad Pipeline (VVSPL) Capacity Expansion Project ahead of schedule
- Completed HPCL's first offshore pipeline laying from OSTT to SS Jetty in Visakhapatnam
- Commissioned Ramanandi Bahadurgarh Pipeline (RBPL) Capacity Expansion Project within schedule and with substantial savings
- Commissioned Uran Chakan Shikrapur LPG Pipeline (UCSPL) Project to substantially reduce the LPG tanker movement on the Mumbai-Pune route
- Strengthened supply infrastructure with completion of Meerut depot revamping project and tank wagon unloading facility project at Kolkata Terminal
- Added to tankage capacities in many locations to ensure enhanced storage capacities and product availability to meet the market demand

Major Ongoing Projects

- Extension of VVSPL from Vijayawada to Dharmapuri Pipeline and construction of marketing terminal at Dharmapuri
- Hassan Cherlapalli LPG Pipeline
- Barmer Palanpur Pipeline

2019-20 Highlights

- Recorded a pipeline throughput of 21.2 MMT
- Converted all POL Pipelines and Station Facilities from BS-IV to BS-VI grade
- Achieved Consolidated Specific Energy Consumption of all Pipelines at 0.0166 (KWH/MT-KM) against a target of 0.0178
- Implemented various initiatives for operational flexibility in pipelines
- Implemented Pipeline Intrusion Detection System (PIDS) in 1,879 km of pipelines. 3,547 km out of 3,716 km Pipeline Network is covered with PIDS
- Carried out pilot project to enhance the effectiveness of PIDS system by developing an AI/ML enabled software
- Installed sectionalising valves in VVSP Mainline. VVSP used dual direction air pigging, thus minimising water plug requirement in compliance with the Petroleum and Natural Gas Regulatory Board (PNGRB) regulations
- Installed Drag Reducing Agent (DRA) dosing facility at Barwala and Mathura to achieve higher flow rate to Kanpur
- Commissioned online transmix blending facility at MDPL Jaipur
- Implemented Pipeline Integrity Management System (PIMS) in 600 km of the network to analyse the integrity status of pipelines
- Implemented initiatives across pipelines to achieve substantial cost savings

The SBUs of HPCL are ably supported by other functions, such as Audit, Corporate Strategy and Planning, Finance, International Trade and Shipping, Legal, Refinery Coordination Department, Market Research, Analysis and Planning among others that create a synergy for the Corporation's superlative performance.

About HPCL

VISION, MISSION AND VALUES

Our obligations and intentions are articulated in our Vision and Mission statements and these are reinforced regularly at all levels of the Company through strategic planning, execution and assessment. Underlined by our unwavering commitment to sustainable development, the continual endeavour is to promote economic prosperity, a healthy environment and vibrant communities, now and in the future.



Vision



To be a world-class energy company known for caring and delighting the customers with high quality products and innovative services across domestic and international markets with aggressive growth and delivering superior financial performance. The Company will be a model of excellence in meeting social commitment, environment, health and safety norms and in employee welfare and relations.

Mission



HPCL, along with its joint ventures, will be a fully integrated Company in the hydrocarbons sector of exploration and production, refining and marketing; focusing on enhancement of productivity, quality and profitability; caring for customers and employees; caring for environment protection and cultural heritage.

It will also attain scale dimensions by diversifying into other energy related fields and by taking up transnational operations.

‘HP FIRST’

We believe in holistic growth and strive to make a difference across the three pillars of sustainable development i.e. Environment, Social and Economic. The ‘HP FIRST’ philosophy is the bedrock of our organisational vision and mission and provides the foundation for the Company’s daily operations.

In continuous endeavour to sustain ‘HP FIRST’ as the way of life, an online appreciation portal was launched on HPCL foundation day. This portal is dedicated to ‘HP FIRST’ values and provides employees an opportunity to acknowledge HPites who have displayed ‘HP FIRST’ values and motivated others to live by them

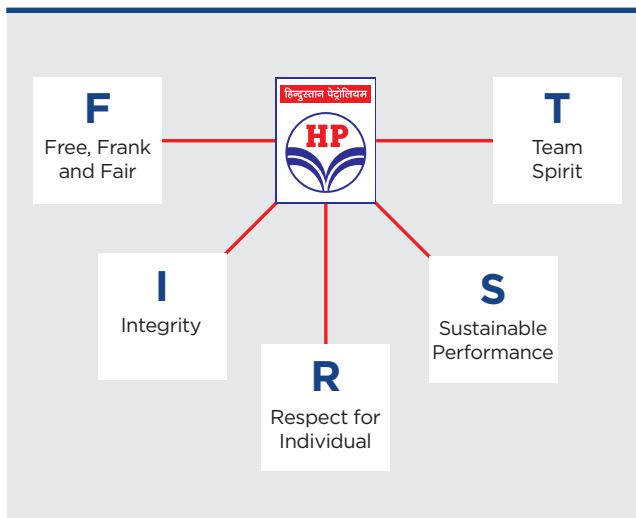

CORPORATE GOVERNANCE

HPCL has a well-defined policy framework for effective implementation of its Corporate Governance practices. The framework comprises the following:

- Code of Conduct for Directors and Senior Management personnel
- Integrity pact to enhance transparency in business operations
- Public grievance redressal mechanism
- Whistle blower policy
- Limits of authority manual
- Procurement manual

HPCL believes in good Corporate Governance practices, ethics, fairness, professionalism and accountability to enhance stakeholder value on a sustainable basis and to build an environment of trust and confidence. Being a public sector enterprise, our activities are subject to review by several external agencies like the Comptroller & Auditor General of India (CAG), the Central Vigilance Commission (CVC), Parliamentary Committees, Statutory Auditors, among others. We are a member of the Global Compact Network India, which is a unit of the UN Global Compact, the largest voluntary corporate initiative in the world. We focus on the principles of human rights, labour standards, environmental norms and ethical practices of UNGC. These areas receive constant attention from the management to ensure continuous compliance.

Key Principles of HPCL's Corporate Governance

- Proper composition of the Board of Directors, size, varied experience and commitment to discharge their responsibilities
- Well-developed internal control systems and processes, risk management and financial reporting
- Full adherence and compliance of laws, rules and regulations
- Timely and balanced disclosures of all material information on operational and financial matters to the stakeholders
- Clearly defined management performance
- Enhanced accuracy and transparency in business operations, performance and financial position

Board of Directors

The Board of Directors is the highest governing body at HPCL. They exercise powers subject to the provisions of the Companies Act, 2013. The Board directs formulation of policies, strategies and goals pertaining to the Corporation's triple bottom line performance in alignment with our vision, mission, values and business strategies.

Being a government company, HPCL Directors are appointed by the Government of India through the Ministry of Petroleum & Natural Gas (MoP&NG), after assessment as per guidelines. The Board is headed by the Chairman and Managing Director appointed by the government in accordance with its policy for Central Public Sector Enterprises (CPSEs).

The Board holds periodic meetings to review and evaluate matters of business, policy and strategic importance for the corporation and provide insight, guidance and approvals across various aspects of business, including human resources, refining, finance, accounting, marketing, strategy, projects, technology, operations, among others. The outcome of the Board meetings are implemented and executed by respective functionaries. In addition to new items of discussion based on agenda, specific progress review of actionable items from previous meetings are also undertaken and discussed. Key decisions of the Board and its Committees are communicated to the stock exchanges.

The MoP&NG (Government of India) undertakes performance evaluation of the Directors at the end of each financial year. This is done through the process of MoU on specified economic, environment and social parameters. The MoU ratings directly affect the performance related pay of the Directors.

Whole-time Directors of the Corporation have a five-year tenure or up to the date of their superannuation or until further orders, whichever is earlier. Further, the tenure of Government Directors is till the period they continue in the Ministry or until further orders, whichever is earlier. For Independent Directors, the tenure is three years or until further orders, whichever is earlier.

About HPCL

The following was the composition of the Board of Directors of HPCL as on March 31, 2020:

Whole-Time Directors



Centre
SHRI MUKESH KUMAR SURANA
Chairman and Managing Director
(DIN:07464675)

Left to Right

SHRI RAKESH MISRI
Director - Marketing
(DIN:07340288)

SHRI PUSHP KUMAR JOSHI
Director - Human Resources
(DIN:05323634)

SHRI VINOD S. SHENOY
Director - Refineries
(DIN:07632981)

SHRI R. KESAVAN
Director - Finance
(DIN:08202118)

Government Nominee Directors



SHRI SUNIL KUMAR
Ex-Officio Director
(DIN: 08467559)



SHRI SUBHASH KUMAR
Part-Time Director
Representative of ONGC
(DIN:07905656)

Independent Directors



SHRI AMAR SINHA
(DIN:07915597)



SHRI SIRAJ HUSSAIN
(DIN:05346215)



SHRI G RAJENDRAN PILLAI
(DIN:08510332)

Board Committees

In accordance with the provisions contained under the Companies Act, 2013 and the SEBI (Listing Obligations and Disclosures Requirements) Regulations, sub-committees of the Board have been formed, which focus on specific areas and make informed decisions within the delegated authority. They are also involved in making recommendations to the Apex Board on various matters, if required. Observations, recommendations and decisions of the Committees are placed before the Board for information and approval. The Board is also apprised about the developments in the Sub Committee meetings.

There are six Board sub-committees as on March 31, 2020:

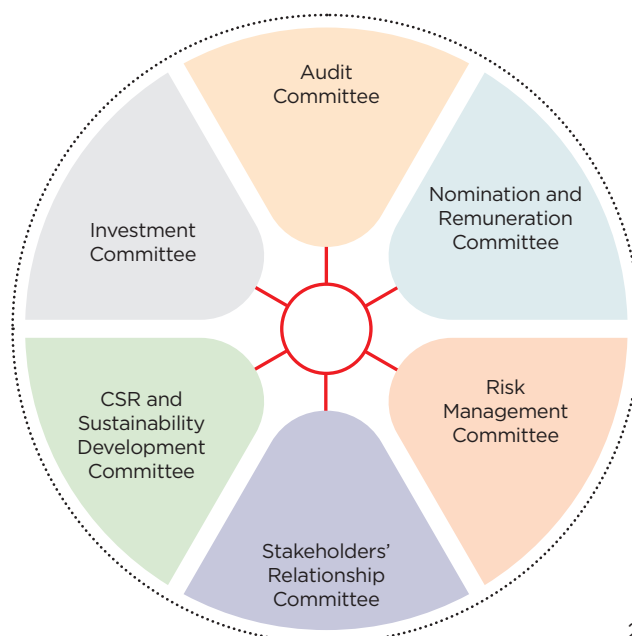

About HPCL

Nomination, Selection Processes and Remuneration

The remuneration, compensation and benefits for the employees are managed by the Nomination and Remuneration Committee constituted by the Board. The terms of reference of the Nomination and Remuneration Committee are as prescribed under Section 178 of the Companies Act, 2013 except to the extent of exemptions granted to Government Companies and as provided under Part D of Chapter II (Corporate Governance) of Regulation 19 of the SEBI (Listing Obligations and Disclosure Requirements) Regulations, 2015. The remuneration of the Whole-time Functional Directors and other officers is fixed by the Government of India in view of the fact that the Company is a Government Company as per Section 2 (45) of the Companies Act, 2013.

The Independent Directors are paid sitting fees for Board meetings and Sub-Committee meetings of the Board attended by them. HPCL does not have a policy of paying commission on profits to any of the Directors of the Corporation. The remuneration payable to officers below the Board level is also approved by the Government of India.

Annual total compensation ratio of highest-paid individual to the median annual total compensation for all employees (excluding the highest paid individual) is 7.11:1 in 2019-20. The ratio of percentage increase in salary of the highest paid individual to the median percentage increase of all other individuals excluding the highest paid individual is [(-)1.523:1].

Golden Peacock Award 2019 for 'Excellence in Corporate Governance' under National category conferred by the Institute of Directors (IOD)



INTERNAL SYSTEMS AND CONTROLS

HPCL has established policies and mechanisms, such as Code of Conduct, Vigilance, Integrity Pact, Whistle Blower Policy, CDA-Conduct, Discipline and Appeal Rules for Executives, Certified Standing Orders for Non-executives to ensure that our decisions, actions and conduct are ethical and transparent. These mechanisms strengthen our commitment to conducting business in an ethical manner, thereby creating a sustainable business.

In line with the requirements of the SEBI (Listing Obligations and Disclosure Requirements) Regulations, 2015, HPCL has framed policies on material subsidiaries and policy on material related party transactions. These are publicly available on our website. Related/material party transactions were approved in line with the provisions contained in the relevant Act/Policies.



Risk Management

The global risk landscape is evolving rapidly in the energy sector, posing challenges and providing opportunities on a continuous basis. A robust risk management function is critical to ensure sustained profitability, long-term viability and competitive advantage for the organisation. As a leading Oil and Gas Company, we are subject to risks, including sustainability risks arising out of economic issues, environmental impact and social responsibility.

HPCL provides utmost importance to sustainability considerations in its daily operations and decision-making. A robust risk management framework along with risk management policies has been designed and implemented by HPCL to not only protect itself from downside and outside risks, but also ensure that we are able to embrace key opportunities that arise. HPCL has created a sustainability risk-aware culture across the organisation, thereby ensuring that key sustainability risks have been identified and are monitored on an ongoing basis.

The Risk Management Steering Committee (RMSC) constituted under the Risk Management Charter and Policy 2007 regularly reviews the process of identification, evaluation and mitigation of risks. The Board is appraised about the risk assessment and mitigation procedures. We engaged the services of an independent expert to bring an external view on our risk management process.

Such initiatives have ensured that sustainability considerations have been embedded into the rhythm of the business, including strategic business planning process, resulting in sustainability becoming a cornerstone of our initiatives and programmes.



Delegation of Authority and Roles and Responsibilities

The Members of the Board, Executive Directors, Chief General Managers and General Managers constitute the Senior Management of the Corporation. The head of SBU/Department is accountable for activities related to the respective SBU/Department's performance. The provisions contained in the Limits of Authority Manual (LAM) guide decisions pertaining to each SBU. The decisions related to key concerns requiring approval from the Committee of Functional Directors (CFD) or the Board as per the LAM are put up for the consideration of the CFD or the Board.

We have detailed manuals and guidelines to facilitate decentralised decision-making at multiple levels of the organisation. Some of these are as follows:

Limits of Authority Manual (LAM)

It defines the scope of authority for the Board, Committee of Functional Directors and the Executive Committee, the Contracts Committee, the Bids Committee and the senior individual positions. Separate chapters on different functions, such as Sales, Crude and Shipping, Capital Projects, Operations and Distribution, Finance, HR and inter-functional groups guide transparent decision-making process, which leaves no room for any uncertainty.

Procurement Manual

It details the procurement procedures while undertaking and finalising procurement contracts. It also clearly provides procurement authorities at multiple levels for procurement activities.

Over and above this, there are manuals at Corporate and SBU levels, which form the basis of guiding decisions and administrative functionalities across our business domains.

About HPCL



Code of Conduct (CoC)

HPCL has a “Code of conduct for Board Members and Senior Management personnel of Hindustan Petroleum Corporation Limited” in compliance with the terms of Regulation 17 (5)(a) of the SEBI (Listing Obligations and Disclosure Requirements) Regulations, 2015, including the duties of Independent Directors as envisaged in Regulation 17 (5) (b) of the SEBI (Listing Obligations and Disclosure Requirements) Regulations, 2015. The Code aims to further enhance the ethical and transparent process in managing the affairs of the Corporation. This Code has been made applicable to:

- a) All Whole-time Directors
- b) All Non-Whole-time Directors, including Independent Directors and
- c) Senior Management Personnel

The Code would be read in conjunction with the Conduct, Discipline and Appeal Rules for officers applicable to Whole-time Directors and Senior Management personnel. All Board Members and Senior Management personnel have provided the Annual Compliance Certificate duly signed by them as on March 31, 2020. During 2019-20, there were no material transactions with Directors or their relatives having potential conflict with the interest of the Company.



Vigilance Mechanism

The vigilance function at HPCL is an integral part of the management approach and supports ethical business decisions. It is focused on preventive and proactive measures to minimise or eliminate deviations from HPCL’s values, policies and procedures to secure the integrity of business operations.

HPCL has an independent Vigilance Department administering related concerns. Our vigilance mechanism is based on the guidelines from the Central Vigilance Commission (CVC) on vigilance management in public sector enterprises and instructions issued from time to time by the Department of Personnel and Training (DoPT) as well as the administrative ministry i.e. Ministry of Petroleum & Natural Gas (MoP&NG). Vigilance complaints are handled in accordance with the complaint handling policies stipulated in Vigilance Manual 2017 of CVC. The Vigilance Department is currently headed by a Chief Vigilance Officer (CVO) who is a cadre officer from Railways, and is assisted by officers from various functions with considerable expertise in the diverse business processes of HPCL.

Preventive vigilance enables us to constantly review procedures and practices, identify susceptible

areas and recalibrate business processes based on constantly changing and dynamic scenarios. A key endeavour in this regard is the dissemination of information through various modes, keeping every employee abreast of the latest updates to enable them to respond proactively to every situation. As part of preventive vigilance activities, surprise and random inspections are carried out by the Vigilance Officers at various business locations including Retail outlets, LPG distributorships, depots/terminals, administrative locations, major project locations etc. Additionally during the year, sustained campaigns were carried out for administering e-Integrity Pledge to various stakeholders. The pledge was taken by employees and other stakeholders in large numbers through e-kiosks, corporate website, LPG IVRS etc. which yielded enrolments of over 2.2 Lakh Integrity Pledges.

Vigilance Awareness Week-2019 (VAW-2019) was celebrated from 28.10.2019 to 02.11.2019 with the central theme as “Integrity- A Way of Life”. Various talks of eminent personalities were organised during the week, including the one by Shri Asutosh Dumbare (IPS), ADGP-ACB, Maharashtra State. Various outreach activities viz. focused group presentations, quizzes, drawing/painting competitions, skits/ street plays, workshops, technical talks, grievance redressal camps, gram sabhas, rallies/walkathons, school/college programmes etc. were undertaken during the week. The activities were shared on social media platforms.

Review of several operating areas were also carried out during the year for system improvement.

We published the eighth edition of the in-house Vigilance Publication ‘Jagaran’ as a compendium of inspiring articles, enriching case studies, informative commentaries, updates on activities conducted to enhance and improve vigilance awareness among our employees.



➤ Release of the eighth edition of the in-house Vigilance Publication ‘Jagaran’

During 2019-20, a total of 233 complaints were attended by the Vigilance Department. These included: 21 complaints carried forward from previous year and 212 complaints received in 2019-20. Out of these, 217 complaints were resolved during 2019-20. Balance 16 complaints remained under investigation as on March 31, 2020.



Ethics and Integrity

Since inception, we have dedicatedly upheld transparency, integrity and accountability. These virtues are integrated into the system as prerequisites to achieving our vision of becoming an integrated energy major. To this end, we have several mechanisms in place:

Public Grievance Redressal Mechanism

HPCL, a customer-centric organisation, has well-defined service standards and strong commitments towards customer delight. We strive to imbue excellence in delivering our services and keep grievances to a bare minimum. Our Public Grievance Redressal system has designated officers at specified times at our major locations to facilitate redressal of grievances of the public. The details of the Grievance Redressal Officer are available on our corporate website. We have toll-free helpline numbers for registering customer complaints. We have customer complaint management systems embedded in our SBUs to handle specific queries, feedback or complaints. We also promote the use of the Centralised Public Grievances Redress and Monitoring System (CPGRAMS), a web-enabled grievance redressal system of the Department of Administrative Reforms & Public Grievances (DARPG) through link on our corporate website. Grievances of citizens are attended promptly and redressed in a meaningful manner by effective coordination and qualitative disposal. We also conduct root cause analysis of grievances and proactively revise our service standards to eliminate recurrence of such cases.

During 2019-20, HPCL effectively disposed 4,126 public grievances received through various modes, with an average resolution time of 15 days, well in advance of the permissible timeline of 30 days as per the directive of Department of Administrative Reforms and Public Grievances [DARPG] and the Prime Minister's Office [PMO]. The grievances were qualitatively redressed with proper closure. With the above mission, HPCL again recorded Nil Pendency of Public Grievances beyond time limit, for the fourth consecutive year.

Right to Information (RTI)

The basic object of the Right to Information Act is to empower citizens, promote transparency and accountability in the working of the Government, contain corruption, and make our democracy truly work for its people. An informed citizen is better equipped to maintain vigilance over governance instruments and make the government more accountable to the governed. The Act is a big step towards making the citizens informed about the activities of the Government. HPCL is a Public Authority under the RTI Act 2005 and complies with all the requirements of the Right to Information Act 2005, including the portion related to proactive disclosures. HPCL receives and handles RTI requests through the RTI online portal at www.rtionline.gov.in which is the unified RTI portal of the Government of India. Regional Managers and Officers across the country, representing different departments, have been appointed as Central Public Information Officers (CPIOs) and Senior Management as the First Appellate Authorities (FAAs) to handle RTI requests received from Indian citizens.

Integrity Pact

HPCL's business relationships with numerous domestic and international contractors and vendors of goods and services are steered towards a well-planned direction with high transparency and ethical standards as guiding lights in the transaction process. We have introduced the Integrity Pact to enhance ethics and transparency in the process of awarding contracts and a Memorandum of Understanding (MoU) has been signed with 'Transparency International' in this regard. This pact was made applicable in the Company effective September 2007 for contracts with a value above ₹1.0 Crore. The Integrity Pact is a part of tender documents to be signed by the Corporation and by the vendor or bidder. The reference received from the vendors are placed before Independent External Monitors (IEMs) for their review and recommendations to the Management for compliance. Meetings of the IEMs are held to brief on the purchase processes followed by the Company.

Whistle Blower Policy

The whistle blower policy of HPCL is approved by the Board and the same is available to stakeholders through the website of the Corporation. This policy provides protection from unfair treatment or victimisation of genuine whistle blowers while warranting disciplinary action against misuse of the policy. It aims to build an environment where employees feel safe and empowered to raise concerns regarding non-compliance with laid rules, regulations and policy directives.

About HPCL

SUPPLY CHAIN

Providing uninterrupted supply of energy solutions calls for end-to-end efficient management of the crude in the customer supply chain. We focus on delivering the right product, in the right quantity safely and in a timely manner by decisively managing each level, including sourcing, refining, supplies, operations, distribution and inventory management. Our downstream value chain is managed by respective Strategic Business Units, focused on SBU-specific metrics and performance management systems to drive efficiency and profitability of the respective SBUs. We have an Integrated Margin Management

department, which acts as a nerve centre of the corporation and takes an end-to-end view on critical processes for planning, enhancing and delivering the net corporate realisation.

We strive to implement continual as well as radical improvements in our supply chain management systems to deliver superior customer services, which enhance profitability, customer loyalty, safety, while reducing carbon footprint, improving energy efficiency and so on.

We encourage the stakeholders in our supply chain to adopt green practices for a sustainable tomorrow.

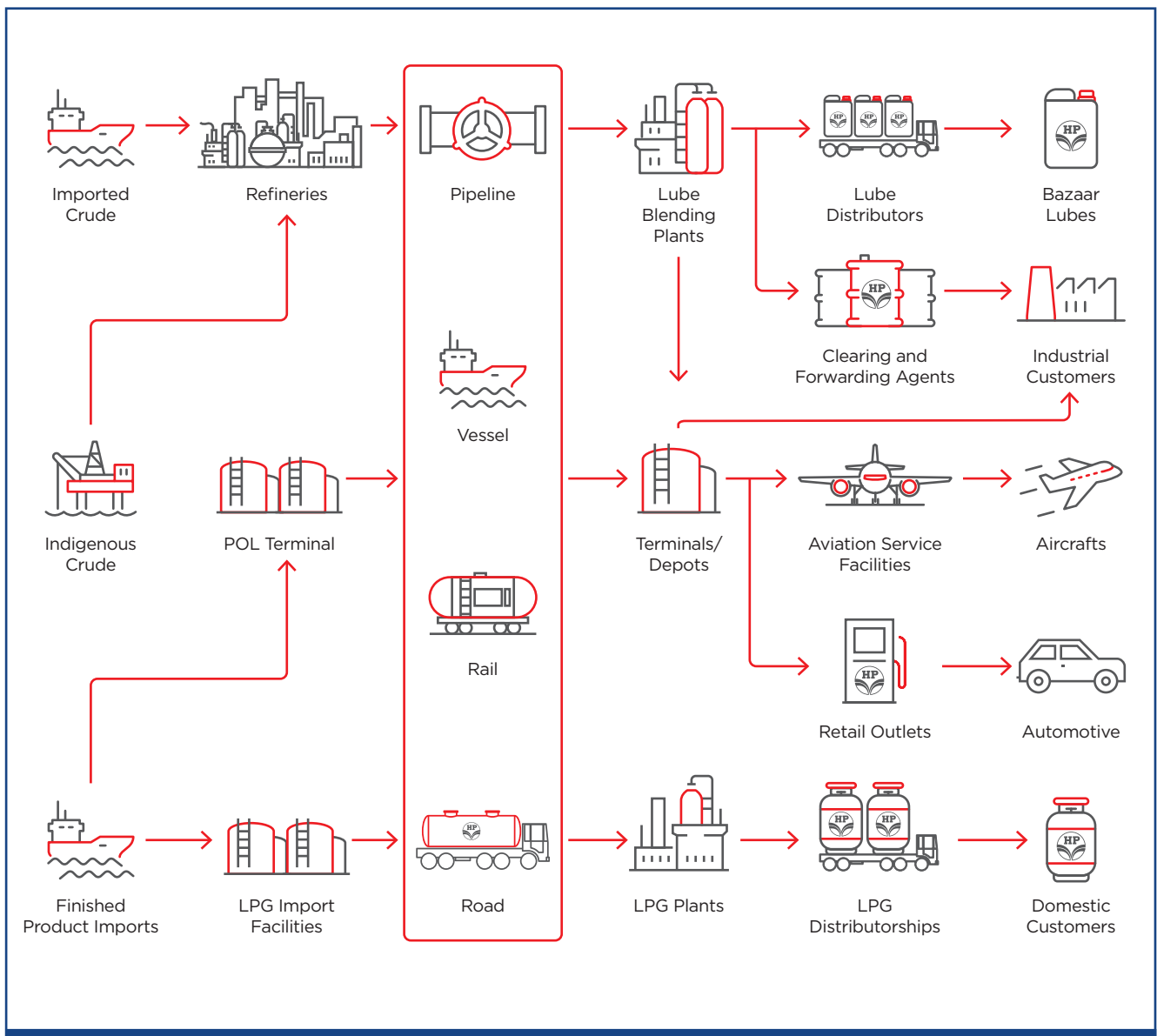

MEMBERSHIPS AND AFFILIATIONS

HPCL actively participates in constructive dialogue on policies and decisions affecting the industry and stakeholders. Our experienced officers take part in consultative committee meetings for setting up policy framework and contribute to providing

insights to MoP&NG and other bodies, such as Oil Industry Safety Directorate (OISD), Petroleum and Natural Gas Regulatory Board (PNGRB), Centre for High Technology (CHT), among others, towards the advancement of public good and nation building.



Institutional Memberships

All India Management Association	Bombay Chamber of Commerce and Industries	Chemicals & Petrochemicals Manufacturers Association	Confederation of Indian Industry
Council for Fair Business Practices	Federation of Indian Chamber of Commerce & Industries	Federation of Indian Petroleum Industry	Global Compact Network India
IMC Chamber of Commerce & Industry	Indo German Chamber of Commerce	Maharashtra Economic Development Council	Press Club of India
Standing Conference of Public Enterprises	The Associated Chambers of Commerce and Industry of India	The Energy and Resources Institute	Vigilance Study Circle



About HPCL

AWARDS AND RECOGNITIONS

During 2019-20, we received multiple awards and recognitions at various international and national forums.

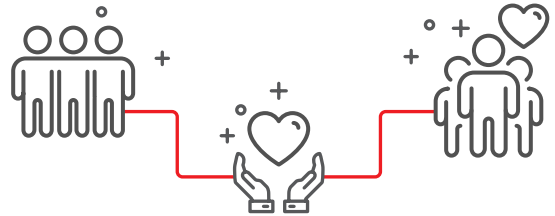

HR and CSR



1. National Corporate Social Responsibility (CSR) award under the 'Contribution to National Priority Areas: Education' category by the Government of India and Honourable Mention in the 'Contribution to National Priority Areas: Support to Differently Abled' category for Project ADAPT
2. Company of the Year for Excellence in Human Resource Management award by Federation of Indian Petroleum Industry (FIPJ)
3. 9th PSE Excellence Awards 2018 under the categories 'Human Resource Management Excellence' and 'Contribution of Women in PSEs'; runners up in 'Corporate Social Responsibility (CSR) & Sustainability' under Maharatna and Navratna category by Indian Chamber of Commerce (ICC)
4. Special Commendation Prize for the '29th National Award for Innovative Training Practices' instituted by ISTD under 'Public Sector' Category.
5. Featured in the Limca Book of Records 2020 for Hum Fit toh India Fit Challenge, Harmonica Challenge and Velocipede Challenge
6. SCOPE Corporate Communication Excellence Awards 2019 for (i) Best Annual Report (ii) 'Innovative Stakeholder Interface' to HP Radar (iii) Best House Journal in 'Hindi Category' to HP Samachar (iii) Best House Journal in 'English Category' to HP News (iv) Best Corporate Communication Campaign & Programme in Internal Communication
7. PRSI National Awards 2019 for (i) Best CSR Project for Childcare, (ii) Best Public Awareness Programme and (iii) Special/Prestige Publication (Expressions) (iv) Corporate Website (v) Sustainable Development Report and (vi) Best Employee Communication Programme by Public Relations Society of India (PRSI)
8. SHRM HR Excellence Awards 2019 to SDI, Visakhapatnam under the category 'Excellence in Community Impact'
9. Best Enterprise Award under the Maharatna category by Forum of Women in Public Sector (WIPS)
10. ASSOCHAM Skill Achievers Gold Award 2019 to the Skill Development Institute (SDI), Visakhapatnam under the category 'Best PSU - Public Sector Training Programme' by ASSOCHAM
11. Global CSR Awards 2020 to SDI Visakhapatnam by Energy and Environment Foundation
12. Swachh Bharat Awards to Swachh Iconic Place Project site, Golden Temple Amritsar by Ministry of Drinking Water and Sanitation
13. CSR Congress Award by Zee Business World
14. 5 Star Rating to SDI Visakhapatnam by National Skill Development Corporation under the Ministry of Skill Development & Entrepreneurship
15. EXCEED Gold Award to MDPL under the category 'Corporate Social Responsibility in Petroleum Storage & Transportation Sector'

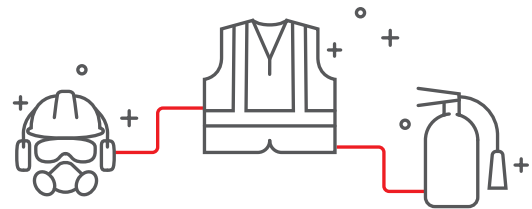
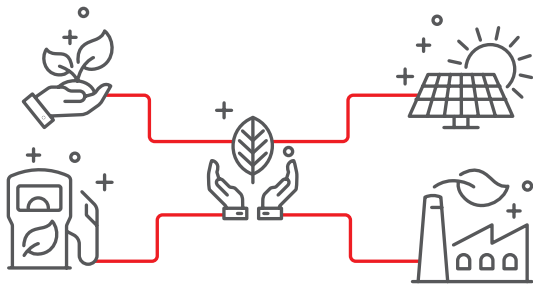

Environment



16. Platinum rating to HPGRDC, Bengaluru by Indian Green building Council (IGBC)
17. Digital PSU Award under the 'Investment in Start-ups and Environment & Sustainability' category at the 7th PSU Award by Governance Now
18. IGBC Green Championship Award for Green Building Designs, promoting Green Complex and development of green belt at locations across the country
19. 5 Star rating conferred on HPGRDC, Bengaluru by Green Rating for Integrated Habitat Assessment (GRIHA) Foundation
20. Greentech Environment Award 2019 to Loni LPG Plant
21. 19th Annual Green tech Environment Award at Green tech Conference and Grow care India annual Environment Award 2019 to Loni Terminal

Safety

22. Safety Award for the Year 2019 to Palghat LPG Plant and Calicut ASF under the 'Medium Factories Category, Subcategory-1 (101-250 Workmen) and Category V (Less than 20 Workmen)' category by the Department of Factories and Boilers, Government of Kerala
23. Fame Safety Excellence Award 2019 -Platinum award to Mangalore LPG Import Facility (MLIF) by Foundation of Accelerated Mass Empowerment

Safety



24. Appreciation Award to Gummidipoondi LPG Plant & Madurai LPG Plant by National Safety Council, Tamil Nadu Chapter
25. Grow Care India Safety Award 2019 to Mangalore LPG Import Facility (MLIF) under Petroleum Storage and Transportation Platinum Category
26. Unnatha Suraksha Puraskara to Mangalore LPG Import Facility (MLIF), Mysore LPG Plant & Mumbai Pune Solapur Pipeline (MPSPL) on 'Safety Excellence' conferred by the National Safety Council
27. Greentech Safety Award 2019 to Mumbai-Pune-Solapur Pipeline (MPSPL), Mundra-Delhi Pipeline (MDPL) and Mazgaon and Silvassa Lube Plants
28. Greentech Safety Award to six LPG Plants (i) Aurangabad, (ii) Gummidipoondi, (iii) Chakan, (iv) Usar (v) Goa and (vi) Madurai
29. Apex India Fire, Safety and Security 2019 Awards conferred to nine HPCL locations
30. SKOCH Award 2019 in the Gold Category to Ramanmandi Rewari Kanpur Pipeline (RRKPL)
31. Coimbatore IRD has been bestowed with International Safety Award 2020 with merit by British Safety Council (BSC)

About HPCL

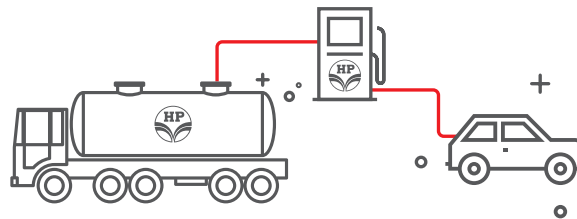

Business



32. 'Jury award' to HPCL at the 9th PSE Excellence Awards 2018 by Indian Chamber of Commerce (ICC)
33. Best Navratna Award in 'Manufacturing Sector' category by M/s. Dun & Bradstreet
34. Golden Peacock Award 2019 for 'Excellence in Corporate Governance' under National category conferred by Institute of Directors (IOD)
35. Reader's Digest Trusted Brand 2019 award in Petrol Station category
36. Asia's Most Promising Brand 2019 to 'poWer' under the category 'Fuel' at Ideas Fest 2019
37. Asia's Most Trusted Brand 2019 conferred on HP Gas by International Brand Consulting Corporation
38. FICCI award conferred for HP 2 FCC catalyst under the 'Product Innovator of the Year in the 'Petrochemicals' category
39. 6th IDC Insights Awards 2019 under the 'Excellence in Data Intelligence' category by International Data Corporation (IDC)
40. Golden Peacock Award 2019 to Information System/ERP for Innovation Management conferred by Institute of Directors in Global Platinum Category
41. Outstanding Performer on BSEBOND Platform award under the category 'PSU Issuer' conferred by the BSE (Bombay Stock Exchange) India
42. Green Channel Status accorded by the Department of Defence Production (Directorate General of Quality Assurance - DGQA) for supply of 16 Lubricants, constituting three-fourths of the lubes requirement of the Indian Army



43. Golden Peacock Award 2019 accorded to Rewari Kanpur Pipeline under the category 'Innovative Product/Service' by IOD
44. Smart Manufacturing Award under 'IoT' category at the Smart Manufacturing Conclave by Indian Express Group
45. Excellence Award for third consecutive year under the category of 'Best Security Practices in Energy Sector' by NASSCOM
46. Digital Transformation Award 2019 to Information System/ERP in category 'Omni-Experience Innovator - Ecosystem Engagement' for Smart Terminal & Digital Supply Chain for 'Excellence in Data intelligence' by International Data Corporation
47. Express Logistics & Supply Chain Leadership Award 2019 under the category of Best Procurement Project; Public Sector to CPO at 13th Express, Logistic and Supply Chain Conclave 2019
48. Best Analytics Solutions Provider of the Year to the IS initiative 'Operations Intelligence System' by Inflection Conference & Awards
49. Insight Technology Award to Information System/ERP by International Data Corporation for leveraging cutting edge technology & automation of processes
50. Tech Senate Award to Information System/ERP for Enterprise Solutions by Express Computers for innovative & sustainable solutions at digital inflexion point



EMBEDDED SUSTAINABILITY

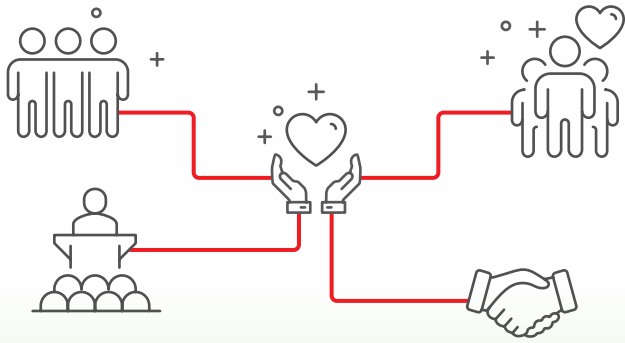

- 39 Governance & Policies
- 40 Stakeholder Engagement
- 46 Materiality



7
C&MD Shri M. K. Surana addressing the shareholders at the 67th Annual General Meeting

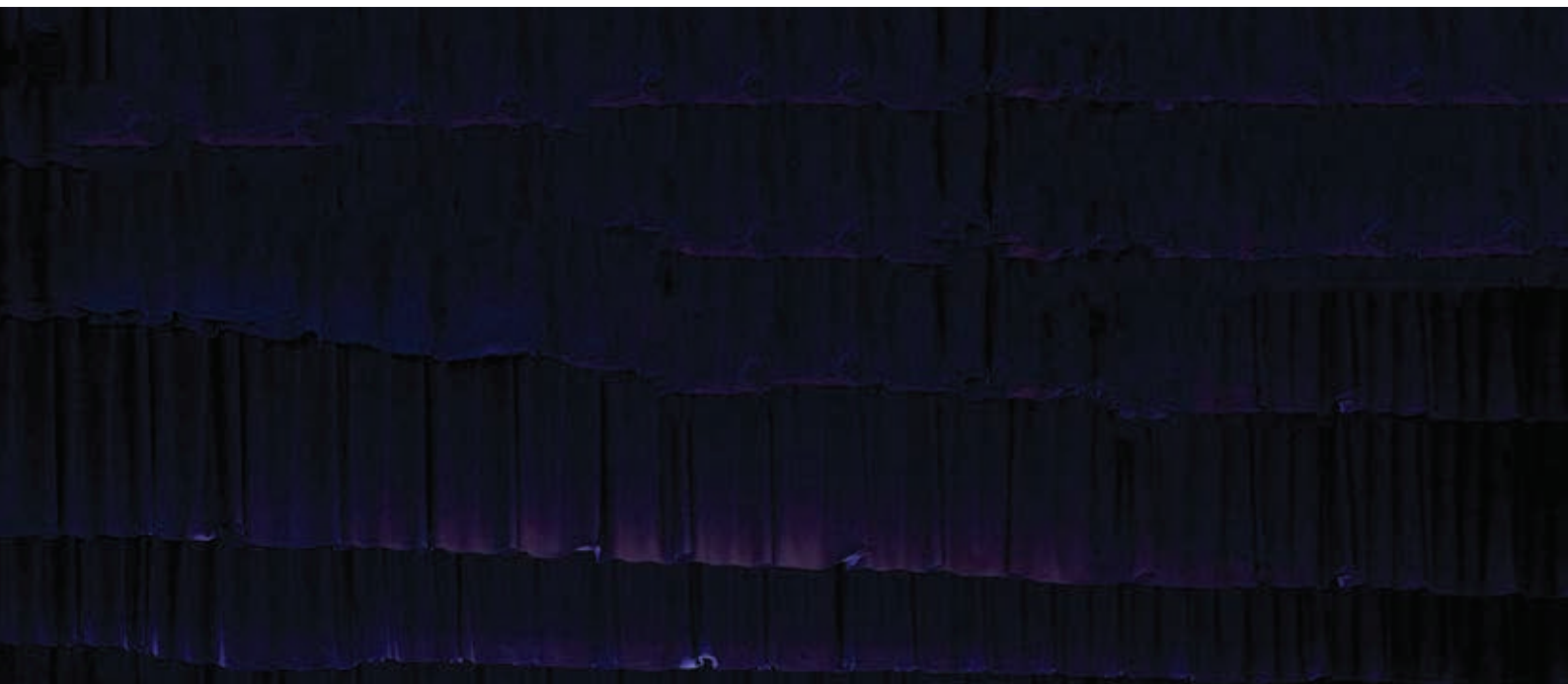

Embedded Sustainability

INSPIRING SHARED GOALS OF SUSTAINABILITY

We firmly believe that the long-term success of our business is rooted in our ability to keep sustainability at the core of our endeavours. The nature of the oil and gas sector business is such that development, social and environmental impacts need to be balanced optimally. Even with the advent of renewable energy and its exponential growth, oil and gas continue to play a major role in maintaining the pace of economic development in many countries throughout the world. It is, therefore, an imperative to adopt sustainable business practices. The deep-rooted spirit of sustainability among us dovetails our decisions and actions, enabling us to stay resilient and consistent in achieving credible performance year on year in the face of a challenging business environment.



The oil and gas sector has been evolving with the need of the hour while gearing up for future challenges, such as maintaining business relevance, facing major policy changes and stricter limits on environmental emissions. To help us realise our Vision through the nitty gritty world of action, we formulated the T20 strategy with a clearly defined roadmap supported on the pillars of safety and integrity. This strategy has aided the Corporation immensely in realising its Vision and Mission.

Our strategic aspirations are thus embedded in the business fabric and appropriately acted upon. Along with clearly defined physical and financial goals, we are focused on areas such as strengthening the core businesses of refining and marketing, enhancing the natural gas business, diversifying into petrochemicals and strategically participating in renewables and upstream businesses.

GOVERNANCE & POLICIES

Sustainability Governance

Effective Corporate Governance remains the most important facet of creating sustained value for the stakeholders. Integration of sustainability into Corporate Governance guides our long-term business strategy.

The governance structure in HPCL embeds sustainability in our business strategy, organisational culture and business verticals. This governance structure helps define a sustainability strategy across the business, set and manage KPIs and reporting processes, strengthen relations with external stakeholders and ensure overall accountability across sustainability aspects.

The Board has constituted a Corporate Social Responsibility and Sustainability Development (CSR&SD) sub-committee, headed by an Independent Director. The sub-committee defines the sustainability vision, reviews the sustainability strategy, identifies projects aligned with our sustainability approach and provides leadership and direction. It also conducts annual review of progress and performance across identified focus areas in sustainability. Corporate HSE Department formally carries out the process of material topics identification, reporting on identified material topics, review and approval of Sustainability Report. During the process, regular feedback is taken from CFD, SBU Heads and other concerned officers.

HPCL's unflinching endeavour to uphold sustainability finds direction in the Sustainable Development Policy adopted by the Company, which places highest importance to aligning efforts in making a meaningful impact on the lives of our stakeholders, while creating shared value for the business.

Sustainable Development Policy

We at HPCL, are committed to achieve the economic, ecological and social responsibility objectives of sustainable development consistently through our varied operations and activities.

We will strive to contribute to sustained overall economic growth by continually improving the efficiency and productivity of our operations. We will execute our business activities in such a way that the ecological balance is not impacted. We will develop and conduct programmes for the community, suitably designed towards building their individual capabilities.

We will:

Promote sustainable development concepts amongst our employees, customers, stakeholders and others.

Integrate the sustainable development objectives and considerations in all our business plans.

Deploy efficient and clean technologies towards realising minimal impact on environment.

Develop and implement good practices for optimal usage of natural resources.

Continuously monitor and control our activities to minimise carbon footprint.

Endeavour to provide a clean, healthy and safe working environment for our employees, neighbours, customers, consumers and stakeholders.

Sustain appropriate development programs for our employees, customers and neighbouring communities.

Incorporate customised management systems to monitor and control progress of Sustainability development objectives.

Remain committed to disseminate information on our sustainability performance.

Embedded Sustainability

STAKEHOLDER ENGAGEMENT

The social fabric of our society calls for interaction to maintain an equilibrium. An organisation needs to understand what its stakeholders have to say just as the stakeholders need to be aware of an organisation’s activities in a transparent manner. Effective dialogue with our stakeholders remains the mainstay of our stakeholder engagement strategy. Our far-reaching network of workforce, vendors, customers and communities help us better understand our material sustainability topics through their inputs. We maintain and promote effective communication channels with our stakeholders, thereby creating sustainable relationships with them. With this approach, we promote the objective of inclusive growth, which is essential for our business as well as beneficial for our stakeholders, who play a pivotal role in our success.

Stakeholder engagement is integral to our sustainability strategy. We follow a defined approach to stakeholder engagement, which ensures systematic interaction with our stakeholders, using diverse modes of engagement, such as one-on-one interactions, annual general meetings, press releases, trainings, group discussions, surveys and grievance redressal mechanisms. Additionally, the Sustainability Division of the Corporate Health, Safety and Environment Department and other line management representing different SBUs engage with stakeholders regularly through structured engagement mechanisms.

Approach

HPCL has established systems which help capture and address the concerns and expectations of its stakeholders. Stakeholder inputs are considered for deliberation and redressal at the appropriate levels,

such as operational and strategic, among others. The stakeholder engagement process undergoes review for continual improvement based on inputs received from stakeholders as well as learnings obtained during the process. This symbiotic approach effectively identifies opportunities for value creation. A receptive platform for productive dialogue with stakeholders helps in appreciating their unique perspectives and challenges, and in the process, builds enduring partnerships.

We analyse concerns that have a potentially high impact and that helps us work towards our sustainability priorities. While developing our previous Sustainability Reports, we reached out to internal and external stakeholders, ensuring adequate representation.

The process followed for compliance of stakeholders’ expectation:

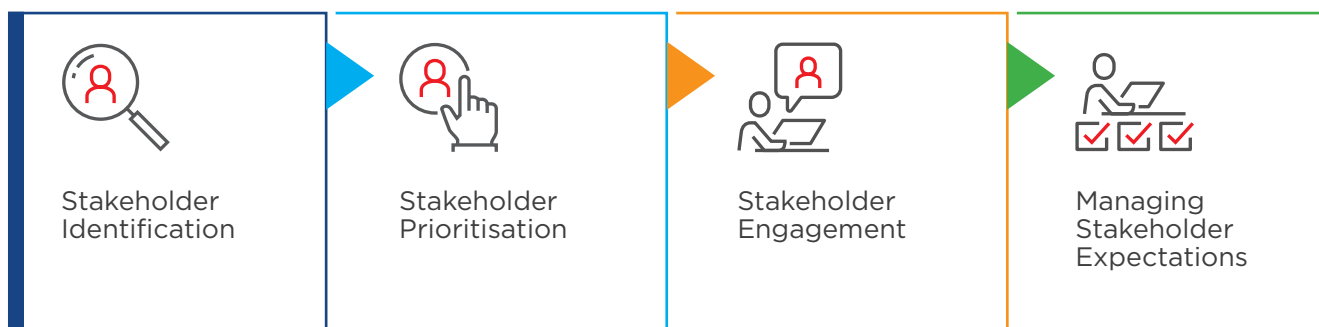

Identification of Stakeholders

We identify stakeholders key to our business through their impact on the organisation and the value we create for them in return. We have identified distinct stakeholder categories for our business. These are:

Internal and External Stakeholder Groups*

Internal Stakeholders	Employees
	▪ Management
	▪ Non-Management
External Stakeholders	Customers
	Dealers and Distributors
	Suppliers/Contractors
	Transporters
	Forecourt Staff at Retail Outlet
	LPG Delivery Person/Staff
	Contract Workmen
	Competitors
	Investors
	Local Community
	Regulatory Departments
	Local Administration
	Shareholders

* - in no order of preference

Stakeholder Prioritisation

Our stakeholder engagement follows a systematic approach with factors such as responsibility, influence, proximity, dependence and representation being used for prioritisation of stakeholders. The extent to which our decisions and actions impact these stakeholders and the effect they may have upon our business is also factored in, in the prioritisation process. The engagement can range from personal interactions on a monthly basis to annual group level meetings to enhance relationship endurance. The following matrix outlines priorities across stakeholder categories:



Stakeholder engagement session in progress

Stakeholder Group	Responsibility	Influence	Proximity	Dependence	Representation
	Towards whom the Company has a responsibility	With influence or decision-making power	Who regularly interact with the Company	Directly or indirectly dependent on the Company	Representing communities, employees and others
Management Employees	X	X	X	X	X
Non-Management Employees	X	X	X	X	X
Dealers and Distributors	X	X	X	X	X
Suppliers/Contractors	X	X	X	X	X
Transporters	X	X	X	X	
Forecourt Staff at Retail Outlet	X		X	X	
LPG Delivery Person/Staff	X		X	X	
Contract Workforce	X		X	X	
Competitors		X			
Investors	X	X	X	X	
Local Community	X	X	X	X	X
Regulatory Departments	X	X	X		
Local Administration	X	X	X		X
Shareholders	X	X	X	X	

Embedded Sustainability

Stakeholder Engagement

The sustainability umbrella covers a multitude of concerns. Stakeholder engagement serves as a tool to understand the reasonable expectations and interests of stakeholders, and their information needs. Myriad stakeholders can have differing knowledge, views as well as appreciation about a particular subject in context of our corporation. Hence, we have developed and refined our stakeholder engagement process through years of conducting engagement workshops across the length and breadth of the country. The learnings have been factored into the mode of engagement and the methodology has been devised to bring in useful outcomes, which provide valuable insights for business and stakeholders.

While developing our sustainability reports for the past three years (2016-17, 2017-18 and 2018-19), we engaged

with over 3,300 internal and external stakeholders across 50+ locations across India. Our detailed materiality assessment included the element of survey design for each of our identified stakeholder group. During stakeholder engagement sessions and materiality assessment exercises, subjects such as sustainable development, environmental issues, latest trends, best practices, regulatory landscapes and future scenarios were covered.

During 2019, we validated the concurrency of the identified material issues by undertaking workshops covering 278 stakeholders, and with response on sample survey of 244 respondents. This validation and re-ranking of the identified material issues was presented in Sustainability Report 2018-19.

Managing Stakeholder Expectations

Key Topics	Modes of Engagement	Our Response
 Management and Non-Management Employees		
Focus on health and safety	<ul style="list-style-type: none"> Monthly/quarterly safety committee meetings 	<ul style="list-style-type: none"> We strive for an incident-free workplace through regular safety trainings, health check-ups and awareness sessions There is a periodic medical check-up that covers our employees under the Periodical Medical Examination (PME) Scheme and is defined by the age profile and nature of work Safety training programmes like Shrestha We keep safety at the core of activities and internalise it as a culture, we conduct Behaviour Based Safety (BBS) training programmes
Aspirations for career progression and higher education	<ul style="list-style-type: none"> Annual performance reviews and appraisal system Education Growth Plan (EGP) 	<ul style="list-style-type: none"> We provide timely performance reviews and appraisals to our employees through appropriate feedback mechanism via online performance review and appraisal system There is a well-defined Promotion Policy for management employees and a Career Development Policy for non-management employees We have devised an education growth plan for our employees to enable them to fulfil their higher education ambitions
Grievance redressal	<ul style="list-style-type: none"> Regular interactions E-platforms 	<ul style="list-style-type: none"> We have effective online grievance redressal mechanisms, such as ICS E-Care, MERC, HR Direct, Reflexion etc. These are made available to our employees to address their concerns
Ecosystem based and need based trainings	<ul style="list-style-type: none"> Regular in-house technical and behavioural trainings Nomination to external trainings, conferences and seminars 	<ul style="list-style-type: none"> With a strong focus on initiatives and programmes to enable our employees to gain competency and enhance their skills, we organise technical and behavioural trainings Some of the capability development initiatives that are available to our employees include certified Petroleum Manager Programme, MBA (Oil & Gas), HP Academy, nomination of employees to international conferences and seminars and so on
Work-life balance	<ul style="list-style-type: none"> Regular interactions 	<ul style="list-style-type: none"> Internal platforms like Yuvantage (for officers below the age of 35 years), Reboot@35+ (For officers above age of 35 years) which encourage officers to explore activities beyond work during their leisure time We have undertaken meticulous efforts to uphold a conducive work environment, taking up activities such as Apnotsav, Hum- Fit-Toh-HP-Fit (HFTHPF), picnics, quiz competitions, festival celebrations and Women’s Day celebrations, to name a few

Key Topics	Modes of Engagement	Our Response
	<ul style="list-style-type: none"> Employee-connect forums 	<ul style="list-style-type: none"> We counsel and extend our support to our employees and their family members through Paramarsh
Rewards and recognition	<ul style="list-style-type: none"> Annual/biannual recognitions schemes 	<ul style="list-style-type: none"> In order to motivate our employees to higher levels of performance, we provide incentives like Performance Related Pay (PRP) to management employees and productivity incentive schemes to non-management staff To reward our deserving employees, we have schemes like HP Icon, Outstanding Achievers Awards, HP Gaurav Award, among others



LPG Distributors

Product quality and delivery	<ul style="list-style-type: none"> Regular distributor meets Regular visits and inspections 	<ul style="list-style-type: none"> We closely examine quality constraints during different phases of our complete value chain We are supporting development of novel solutions and utilising technologies, such as a Vehicle Tracking System (VTS), Optimised Logistics Assistant (OLA), online inventory monitoring, online LPG connection, etc. to ensure timely product delivery Our operating workforce carries out regular inspections
Safety	<ul style="list-style-type: none"> Training programmes on safety Regular inspections and safety audits 	<ul style="list-style-type: none"> The distributors are consistently guided on safe management of products Timely safety audits and reviews are carried out at retail outlets and LPG distributors
Competition from peers	<ul style="list-style-type: none"> One-on-one meetings 	<ul style="list-style-type: none"> Appropriate solutions are identified and executed based on the situation



Retail Dealers

Upgradation of outlet and dispensing units	<ul style="list-style-type: none"> One-on-one discussions Regular dealer meets 	<ul style="list-style-type: none"> We acquire DUs with the most up-to-date configuration and provide the same to our dealers
Improvement in vendor services	<ul style="list-style-type: none"> Regular meetings with vendors and dealers 	<ul style="list-style-type: none"> We have established a portal to lodge, review and settle grievances within a definite period. Also, action is taken against defaulting vendors An effective monitoring system is established for compliance



Supplier and Vendors

Health and safety	<ul style="list-style-type: none"> Training programmes on safety Regular health check-ups Regular meetings 	<ul style="list-style-type: none"> The suppliers and contractors are frequently involved in training programmes and fire drills planned by the working locations Timely health check-ups are arranged with the support of renowned hospitals To stress on secure and safe driving practices, safety parameters, trainings and awareness campaigns, such as HP-SOW encompassing technical and behavioural aspects are carried out for our transporters and their crew regularly
Higher running and maintenance costs	<ul style="list-style-type: none"> Trainings Tank truck health check-up 	<ul style="list-style-type: none"> To bring about awareness on fuel conservation and defensive driving habits, regular training programmes are arranged Through co-ordination with leading OEMs, we organise camps for tank truck fleet. We also reward the top performing drivers
Complaints redressal mechanism	<ul style="list-style-type: none"> Online platforms One-on-one meetings 	<ul style="list-style-type: none"> We have a strong grievance mechanism for our suppliers and contractors. Complaints can be directed to the unit heads at the operating locations on a specified day and at a specified time every week
Improved RTKM transportation rates	<ul style="list-style-type: none"> Regular meets and discussions One-on-one interactions 	<ul style="list-style-type: none"> We have implemented the improved Online Logistics Assistant (OLA) in line with local requirements and necessities

Embedded Sustainability

Key Topics	Modes of Engagement	Our Response
Increased transparency Delay in tendering process	<ul style="list-style-type: none"> ▪ Regular supplier meets at operating level ▪ One-on-one meetings ▪ Panel meetings ▪ Pre-bid meetings 	<ul style="list-style-type: none"> ▪ In order to ensure transparency and reliability in the bidding process, we have a real-time tendering process ▪ We arrange panel meetings with select representatives
On-time payments	<ul style="list-style-type: none"> ▪ Email communications ▪ One-on-one meetings ▪ Online platforms 	<ul style="list-style-type: none"> ▪ To cater to online payments, a robust system has been set up, which enables transporters to check their payment status, taxes and amount of TDS deducted
Payment process	<ul style="list-style-type: none"> ▪ Online platforms ▪ Need-based communications ▪ Vendor trainings 	<ul style="list-style-type: none"> ▪ We have an integrated disbursement module, which is a platform through which bills can be submitted and tracked by the vendors ▪ In our thrust to reduce cycle time and enhance transparency, we are constantly automating and upgrading existing processes



Delivery Men

Customer retention	<ul style="list-style-type: none"> ▪ Regular training sessions 	<ul style="list-style-type: none"> ▪ To help our delivery staff enhance their knowledge and instil an attitude to create differentiated customer experiences, programmes like Ji Haan Samarth and Samvad are undertaken
Training needs	<ul style="list-style-type: none"> ▪ Regular interactions ▪ Training sessions on safety 	<ul style="list-style-type: none"> ▪ We have specific SOPs for delivery men, both in LPG and Retail, on safe use and handling of products ▪ Training sessions are organised for the delivery men at regular intervals





Contract Workers

Health and safety	<ul style="list-style-type: none"> ▪ Annual health check-ups ▪ Regular wellness sessions 	<ul style="list-style-type: none"> ▪ We arrange health check-ups of our contract workforce and organise frequent sessions on healthy living ▪ We strive towards enhancing the well-being and productivity of our workforce by promoting good health and safety practices
Regular payment	<ul style="list-style-type: none"> ▪ Regular interaction ▪ Need-based communication 	<ul style="list-style-type: none"> ▪ We arrange 'Prerna' awareness programmes on Provident Fund and ESI-related matters, thus enabling the contract workforce to understand minimum wages in a more detailed way
Training needs	<ul style="list-style-type: none"> ▪ Regular trainings 	<ul style="list-style-type: none"> ▪ We carry out regular trainings on workplace safety and emergency preparedness



Regulators

Compliance	<ul style="list-style-type: none"> ▪ Regular interactions with government departments and statutory bodies 	<ul style="list-style-type: none"> ▪ We make sure that timely compliance with applicable statutory regulations and local laws is fulfilled through an Alert Management System ▪ We ensure that there is regular interaction with various government departments and statutory bodies on compliance related matters
Disaster management	<ul style="list-style-type: none"> ▪ Training on safety issues and mock drills for emergency preparedness ▪ Mutual-aid meetings ▪ Meetings with local authorities 	<ul style="list-style-type: none"> ▪ We engage with members from nearby communities and neighbouring industries during on-site and off-site mock drills to augment their level of preparedness and instil a sense of confidence

Key Topics	Modes of Engagement	Our Response
 <h2>Communities</h2>		
Community development	<ul style="list-style-type: none"> Regular interaction with the community through our CSR initiatives 	<ul style="list-style-type: none"> We constantly engage in CSR activities in areas of childcare, education, healthcare, environment, community development, sports, skill development etc.
Meeting project deadlines	<ul style="list-style-type: none"> Meetings with local administration, NGOs and implementing agencies 	<ul style="list-style-type: none"> We closely work with local administration, NGOs and implementing agencies to enlighten them on the process and perspectives of projects Timely follow-up is ensured for completion of identified projects within the defined time period
More support and regular meetings	<ul style="list-style-type: none"> Regular meetings with communities 	<ul style="list-style-type: none"> We are in regular contact with the local communities to upgrade and improve the facilities provided to them
 <h2>Shareholders and Investors</h2>		
Financial performance	<ul style="list-style-type: none"> Annual Report Periodic press releases Annual General Meeting Analyst meet 	<ul style="list-style-type: none"> We apprise our shareholders and investors on the existing business environment and the Corporation's strategy to encounter new challenges in the future
Good corporate ethics and compliance	<ul style="list-style-type: none"> Regular meetings Online platform 	<ul style="list-style-type: none"> We have a Stakeholders Relationship Committee to address the grievances of security holders To better recognise the apprehensions of our shareholders, we also seek their feedback
 <h2>Customers</h2>		
Awareness on safety and environment aspects	<ul style="list-style-type: none"> Periodic campaigns on safety and resource conservation 	<ul style="list-style-type: none"> We promote awareness sessions on safety to enhance customer awareness on safe usage of products Dedicated safety clinics are set up for LPG consumers, including PMUY consumers to bring about awareness on safe handling of LPG To sensitise the masses and raise awareness among them, we conduct programmes on conservation of Oil and Gas at various locations, retail outlets and LPG distributorships
Product quality and service standards	<ul style="list-style-type: none"> Periodic customer satisfaction surveys and customer meets 	<ul style="list-style-type: none"> To avoid any degradation in quality and maintain products of highest quality standards right from refining to distribution, we have established adequate systems and processes We are constantly upgrading to products with minimum environmental impact Yearly customer satisfaction assessments and surveys are being organised to receive feedback
Resolving complaints	<ul style="list-style-type: none"> One-on-one meetings Need-based communication Online complaint management system 	<ul style="list-style-type: none"> By means of multi-language online applications, we ensure customer connect is strengthened To attend to our customer complaints on a timely basis, we have effective complaint management systems in place We also ensure alignment with the Centralised Public Grievances Redress & Monitoring System (CPGRAMS)

Embedded Sustainability

MATERIALITY

Material aspects are issues that have significant economic, environmental and social impacts on a business or are relevant for and influence the decisions of its stakeholders substantially. Materiality assessment is an important step in formulating a sustainability approach. It helps determine business priorities and stakeholder expectations, providing direction for reporting communication on them.

During the development of previous sustainability reports, we engaged with 3,300+ internal and external stakeholders and captured their feedback on material concerns. The exercise typically involved appraising different stakeholder categories of the relevance of the issues and requesting them to rank them in order of importance. During 2019, we validated the concurrency of the identified material issues by undertaking workshops, covering 278 stakeholders and with response on sample survey of

244 nos. Qualitative feedback about material topics was obtained from the participants, which was used as an input in the materiality re-validation process. The feedback outcomes indicated that all material concerns identified during previous reporting cycle are still relevant to the business and our stakeholders with a perception shift as depicted below in the matrix. This validation and re-ranking of the identified material issues was presented in Sustainability Report 2018-19.

Our material topics for 2019-20 continue to remain the same as validated during the materiality exercise done for Sustainability Report 2018-19. In the Report, we continued to report on the issues validated earlier as we do not perceive any major change in the operating context of the business during the reporting period. With the changing scenario, organisations across sectors are reviewing priorities in line with the current changes.



7
Shareholders at the 67th Annual General Meeting

Materiality Matrix

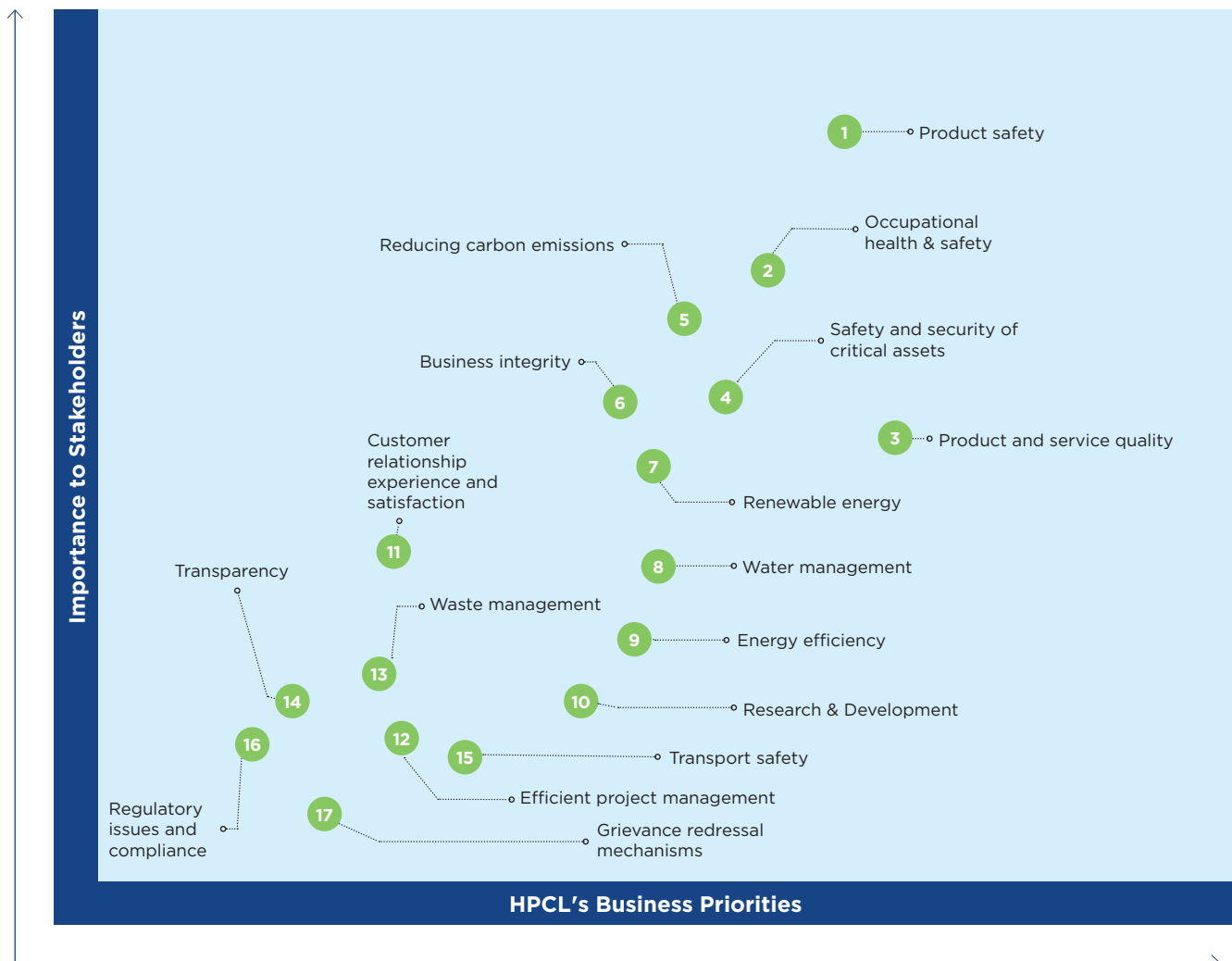

The topics are given with their linkage to the GRI Standards and the reporting boundary. This report delves into our Corporation's approach, performance and future aspirations on these topics.

Sr no.	Material Topic	GRI Standards	Boundary
1	Product Safety	GRI 416 and 417	Internal/External
2	Occupational Health & Safety	GRI 403	Internal
3	Product and Service Quality	OG 8	Internal/External
4	Safety and Security of Critical Assets	Non GRI	Internal/External
5	Reducing Carbon Emissions	GRI 305	Internal/External
6	Business Integrity	GRI 205 and 206	Internal/ External
7	Renewable Energy	GRI 302, OG 2, OG 3 and OG 14	Internal
8	Water Management	GRI 303	Internal
9	Energy Efficiency	GRI 302	Internal
10	Research and Development	Non GRI	Internal
11	Customer Relationship Experience and Satisfaction	Non GRI	External
12	Efficient Project Management	Non GRI	Internal
13	Waste Management	GRI 306	Internal/External
14	Transparency	GRI 102	Internal
15	Transport Safety	Non GRI	Internal/External
16	Regulatory Issues and Compliance	GRI 307 and 419	Internal/External
17	Grievance Redressal Mechanisms	Non GRI	Internal

ECONOMIC PERFORMANCE

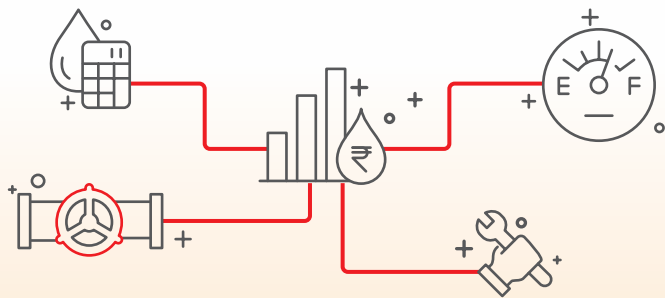

- 51 Financial Performance
- 52 Physical Performance
- 53 Strategic Planning Initiatives

7
Palanpur Vadodara Pipeline
Project was completed
during the year





Economic Performance

DELIVERING RESPONSIBLY

Maharatna Status

In a significant milestone in the prestige of HPCL, Government of India has conferred 'Maharatna' status on October 24, 2019, featuring us in an elite list of 10 Central Public Sector Enterprises in India. The honour, coming with huge responsibilities, is a most cherished moment to every stakeholder of the Corporation and the Board rededicates themselves to the services of the Members.

The Indian economy grew by 4.2% in 2019-20 and remains one of the fastest growing major economies in the world. During 2019-20, consumption of petroleum product in the country increased by over 4.7 Million Metric Tonnes (MMT) to reach about 213.68 MMT and registered marginal growth of 0.2%. Due to the COVID-19 outbreak and subsequent nationwide lockdown as a containment measure during March 2020, the consumption of major petroleum products was adversely affected.

The year 2019-20, specially the last quarter, saw unprecedented events like the COVID-19 pandemic leading to nationwide lockdown and demand contraction on the back of generally sluggish global economic activities. This coupled with the inability of oil producing countries to reach a consensus

to rebalance the supply demand situation, led to unprecedented volatility in crude oil and product prices and in exchange rates. Surplus inventories, lower demand and geopolitical situations led to one of the steepest falls in crude oil prices in the last two decades. The nationwide lockdown to contain the spread of the pandemic in India resulted in significant demand contraction in the last part of March 2020, necessitating regulated refinery operations.

In spite of severe challenges, we continued our operations without any disruption to ensure availability of LPG, Petrol and Diesel for essential services and the general public while ensuring the safety and well-being of our stakeholders and the workforce.

For the financial year 2019-20, HPCL achieved Profit After Tax (PAT) of ₹2,637 Crore resulting in earnings per share of ₹17.31. HPCL continues to command strong credit ratings assigned by various credit rating agencies. We consistently strive to create sustainable value for stakeholders. We deployed comprehensive systems and processes to monitor our financial performance. We leveraged technology, robust supply chain network, R&D, ever-expanding infrastructure, exceptional customer service, and forayed into new business streams to ensure sustainable growth.



71 Launch of 2 kg cylinder under 'APPU' brand of HP GAS

FINANCIAL PERFORMANCE

Economic Value Generated	2019-20	2018-19	2017-18
Total Revenue	2,89,255.10	298,621.32*	2,45,934.58
Profit After Tax	2,637.26	6,028.66	6,357.07
Economic Value Distributed	2019-20	2018-19	2017-18
Operating & Service Cost	9,270.28	8,259.81*	7,252.52
Employee Wages and Benefits	3,193.46	2,936.91*	2,858.52
Payment to Providers of Capital	2,808.54	2,379.28	3,360.56
Contribution to Exchequer	76,133.41	73,350.33	69,751.51
Community Investment	182.24	159.81	156.86

* All figures are in ₹ Crore

* Figures of 2018-19 are reclassified as per current year's accounts/performance profile.

The economic performance was affected owing to impact of inventory losses due to sharp fall in crude prices and exchange rate fluctuations.

Shareholding Pattern

As on March 31, 2020, the shareholding pattern was as follows:

(% of Total Issued Shares)

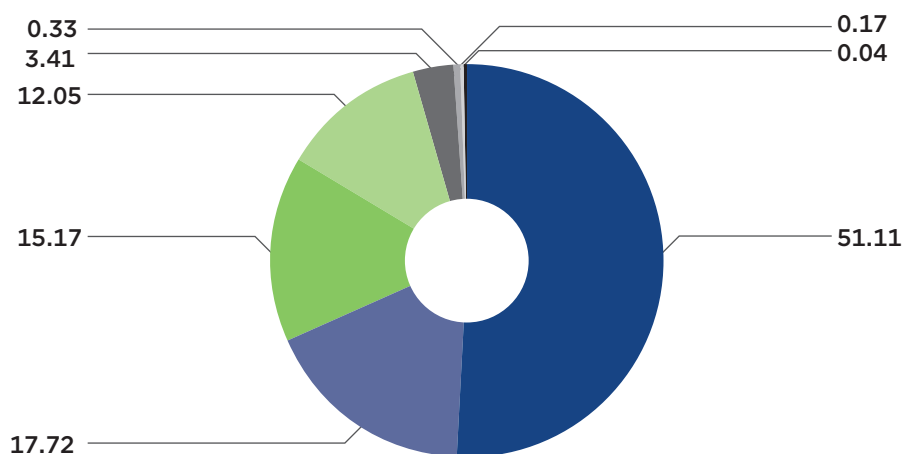

● Oil and Natural Gas Corporation Ltd.

● FII/OCBs

● Mutual funds (Includes alternate investment funds)

● Others

● Financial institutions

● Foreign nationals (Includes NRI, NRI-Repat, Individuals)

● Banks

● Employees (Physical)

Economic Performance

PHYSICAL PERFORMANCE

Refineries

Our refineries have been consistently performing over the years, maintaining a stellar track-record. During 2019-20, both HPCL refineries at Mumbai and Visakhapatnam maintained sound physical performance with combined capacity utilisation of ~108.7%. Effective management of intermediate streams evacuation as well as meticulous handling of two grades of MS and HSD during the interim period of rollout of BS-VI grade of fuels at both the refineries was a key factor in achieving the performance.

Crude throughput

Refinery	2019-20	2018-19	2017-18
	MMT	MMT	MMT
Mumbai	8.07	8.67	8.64
Visakh	9.11	9.77	9.64

Operating Performance in 2019-20

Refinery	Crude Throughput	Capacity Utilisation	Specific Energy Consumption	Fuel and Loss	Distillate Yield	Gross Refinery Margin
	MMT	%	MBN	%	%	(\$/bbl)
Mumbai	8.07	107.5	84.53	7.13	77.0	3.63
Visakh	9.11	109.4	84.15	7.46	72.1	(1.30)

Marketing

We have achieved a landmark sales volume of 39.64 MMT (including exports) with a market share of around 21% amongst the PSU category. We maintained a strong market position in comparison to our peers through continuous effort to ensure customer satisfaction.

Marketing SBUs	2019-20	2018-19	2017-18
	MMT	MMT	MMT
Total Sales Volume	39.64	38.7	36.9



Team at Mumbai Refinery Expansion Project

STRATEGIC PLANNING INITIATIVES



HPCL has developed its 5-year strategy roadmap christened 'T20' along with a detailed implementation plan up to the year 2020-21 to traverse through uncertainties and challenges of the future business environment. Monitoring and evaluation of the progress across various initiatives envisioned in the strategy action plan were continued during the year. HPCL is continuously enhancing its ability to navigate future challenges by strengthening the existing businesses of refining and marketing and incorporation of new business lines, including petrochemicals and natural gas. Our R&D capabilities are continuously scaled up to develop new technologies and products. Focus is on building a diversified and flexible business portfolio aligned with the needs of the dynamic market alongside expansion of business footprint overseas. To keep pace with the transition in technological and customer preferences, the Company is focusing on value creation that leverages emerging digital technologies to transform and enhance IT capabilities.

We are focused on expanding our refineries and marketing infrastructure towards strengthening the existing business. The greenfield and brownfield refinery expansion projects achieved significant physical and financial progress during the year. Various marketing infrastructure and expansion projects were commissioned during the year. In the natural gas sector, HPCL/HPCL JVs are enhancing foothold with availability of authorisation for setting up of city gas distribution (CGD) network in 20 geographical areas in nine states with planned participation in the entire value chain of natural gas. With identification of petrochemicals as a key lever

for future growth, focused actions have been initiated to foray into the sector. Large-scale investments are underway to build petrochemical manufacturing capacities. A robust marketing strategy has been formulated and efforts are underway to build organisational capabilities for marketing of petrochemicals. To enhance our R&D capabilities, the existing infrastructure is being augmented and new laboratories are under development.

We are exploring new business opportunities with participation in the Electric Vehicle (EV) ecosystem with installation of EV charging stations in retail outlets. New avenues of value creation in the EV ecosystem, including battery swapping and energy storage solutions are being explored in collaboration with various technology Start-ups and OEMs. We commenced incubation of 23 Start-ups under the 'HPCL Start-up India' initiative towards emerging opportunities.

Digital is fast evolving to become a key driver for business transformation and delivering value to customers. A focused approach is undertaken that leverages emerging technologies to formulate an implementation strategy of various digital technological innovations in businesses. The digital transformation in the organisation is being galvanised through a dedicated team to ensure focus, momentum and sustenance of value realisation. Through a multipronged approach, a detailed process had been developed in 2019-20 by which various strategic digital initiatives across business units and functions across the organisation were identified for implementation.

Economic Performance

Central Procurement Organisation

The Central Procurement Organisation (CPO) at HPCL has continuously delivered procurement excellence since inception, with enhanced efficiency and transparency ensuring policy compliances. CPO handled procurement for SBUs, Corporate and zones by placing purchase orders while recording substantial savings over benchmarked prices through Strategic Procurement. CPO for the first time under SATAT (Sustainable Alternative Towards Affordable Transportation) scheme of MoP&NG, finalised orders for biodiesel from UCO (Used Cooking Oil) to be supplied over three years. CPO also handled Ethanol procurement during the year.

Promotion of Local Enterprises

The focus on Micro and Small Enterprises (MSEs) towards compliance with public procurement policy has helped HPCL register 30.47% procurement from MSEs, surpassing the target of 25%. CPO has actively driven various initiatives undertaken by the Government of India to strengthen the ecosystem for MSEs in the country.

To promote the objectives of procurement from MSEs as laid down in the public procurement policy, 32 Vendor Development Programme / Buyer-Supplier meets for MSEs were conducted during 2019-20. Additionally, we ensured participation in the Buyer-Seller meets organised by Micro, Small and Medium Enterprises-Development Institute (MSME-DI), Confederation of Indian Industry (CII) and Federation of Indian Chambers of Commerce and Industry (FICCI) programmes to explain to participating MSEs about HPCL's procurement processes. In all such meetings, detailed presentation to MSE vendors were given by sharing procurement opportunities vendor registration process, tendering process, TReDS platform etc.



71
CPO entered agreement with RXIL for bill discounting facility for HPCL MSE vendors

We extended benefits like exemption of Earnest Money Deposit (EMD), allowed to supply a portion quoting within +15% on matching L1 rates and up to 25% of requirement etc. Regular order, including developmental order/trial order were also released to improve capacity and capability of local vendors, including MSEs. HPCL has also been fully abiding by the policy related to boost the local content under Make in India campaign.

CPO entered agreement with RXIL for bill discounting facility for HPCL MSE vendors during the year. A total of 142 MSE vendors were onboarded on TReDS and bills worth ₹206.20 Crore were discounted during the year.

Procurement for commonly used goods and services worth over ₹30.61 Crore was done through GeM (Government e-Marketplace).

Integrated Margin Management

During the year, our Integrated Margin Management (IMM) group continued its efforts to drive various initiatives to enhance Net Corporate Margin with a focus on key performance areas, such as:

- Margin improvement opportunities in crude oils sourcing
- Maximising refineries crude throughput
- Enhancing value added products
- Improving capacity utilisation of cross-country pipeline network
- Driving improvement ideas

The year 2019-20 witnessed wide volatility in crude prices and many key events that will have long lasting impact on crude prices. These events include US-China trade war, implementation of IMO-2020, disagreement between OPEC and Non-OPEC members on extension and deepening of crude cuts amid the ongoing demand crisis and the pandemic, which affected over 192 countries. Sensing the opportunity, lower Brent Dubai differential and higher VLSFO margins, the low sulphur spot crude was maximised and for the first time, 3 and 4 Million-barrel per month low sulphur crude was procured for Visakh Refinery in post IMO period.

For optimisation of the supply chain, IMM helped improve the utilisation of pipeline network, thereby achieving pipeline throughput of over 21 MMT through meticulous planning of linkages and exchanges with OMCs. Logistics cost optimisation was continued through realignment of secondary linkages. As a part of optimising the supply chain of Lube SBU, a pilot was conceptualised and implemented for Continuous Replenishment System (CRS) in Lubes distribution.

IMM group continued to drive various margin improvement ideas generated across the Company through a structured Initiative Management Office, named as idea Junction that regularly tracks the execution of these ideas and reports to the Management. During 2019-20, over 30 idea workshops were conducted across SBUs/hierarchies that helped in generating in excess of 2,000 ideas. The employee participation in idea submission went up to a record

13%.The processing of ideas by stakeholders in the business units and functions across the idea funnel led to significant additional revenue generation for us across the value chain, thereby inculcating innovation as a culture.

As a part of IMM, the Oil Price Risk Management (OPRM) group continued its activities towards stabilising margins by formalising hedging strategies for refinery margin and providing hedging solutions for crude, products, and intermediates.

Information Systems

Embracing technology is crucial to steer a business towards long-term success. Every business relies on technology in varied capacities. Technology helps businesses improve productivity by enhanced engagement and collaboration, reducing manual/redundant activities, aligning business processes with business objectives and enhancing transparency.

The exponential pace of change in technology offers infinite opportunities to businesses in being ahead of the curve. We are continuously innovating, developing and deploying new technologies for operational excellence and delighting customers for sustainable growth.

For greater digital agility, we are preparing to roll out an ERP modernisation initiative. The initiative includes re-engineering of business processes mapped to new modernised ERP platform.

Business Intelligence (BI) systems help companies make informed decisions by providing crucial information on current and historical data of the company along with future trends. Our Corporation has been utilising BI effectively and upgrading it periodically.

Digital initiatives undertaken during the year include:

Implementation and roll-out of Customer Relationship Management (CRM) tool to manage our customer interactions on a digital platform. This system aims to obtain feedback from customers on resolution of the service request to help serve them better

Development of portal for digital collections using Rupay Card, BHIM UPI, QR code

Development of portal to provide end-to-end visibility for our army customers from indent to payment with features, such as auto creation of deliver order and invoice submission workflow

Facilitation of LPG SBU for secondary sales analysis in LPG market through DCMS analytics by seamless integration with CDCMS and JDE

Development of BI interface for Surveillance Safety Audit and Sustainability applications

Development of various employees related applications for enhanced user experience and digitalising the processes viz. New Superannuation Benefit Fund Scheme (SBFS) Application, Online Training Database Module for O&D, LPG and Pipeline SBU and HPMDI Campus Maintenance Application with QR code

Implementation of digital initiatives like new portal for the Ministry to monitor vendor payments, integration of external Government e-Marketplace (GeM) portal with HPCL JDE with real-time data exchange and digitalisation of tank gauge ticket @ MR (e-Gauge Ticket), among others

Information Security and Compliance

Information security continues to be one of our key focus areas. During the year, we re-certified the data centres with latest ISO 27001 security standards. Apart from regular security solutions, HPCL implemented advanced security solutions to accurately identify Advanced Persistent Threat (APT) attacks to protect core information assets. Privileged Identity Management (PIM) solutions were implemented during the year to monitor and protect super user accounts in our IT environment. Stringent security controls were put in place during the year to protect the privacy of personal data of stakeholders.

ENVIRONMENTAL PERFORMANCE

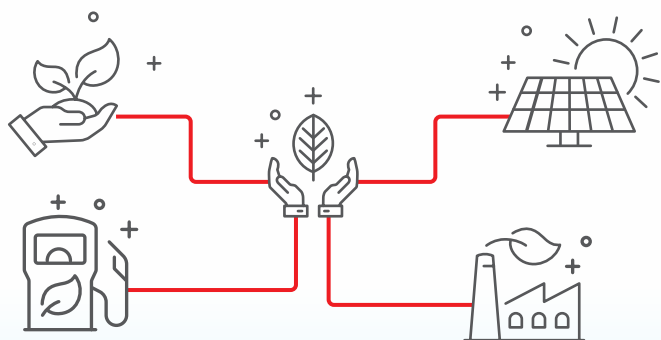

- 60 Materials Management
- 61 Energy Performance
- 64 Managing our Carbon Footprint
- 68 Renewable Energy Footprint
- 69 Water Management
- 72 Waste Management
- 74 Green Outlook
- 75 Driving Sustainability through Start-ups

↗
A regular visitor at one
of our POL depots





Environmental Performance

FUELLING A CLEANER FUTURE

The world is facing an existential threat in the form of climate change. The threat is the result of long-standing exploitation and overconsumption of natural resources. Environmentalists predict that if we continue along our current path the consequences would be devastating, bearing tremendous implications on our habitats and the future of the impending generations.

Human influence is believed to be the dominant cause for climate change. The impact of climate change is visible in the form of changes in frequency and intensity of extreme climatic events, such as heat waves, cyclones, extreme rainfall, droughts, reduction in water availability, loss of land mass and vector borne diseases, among others. Our planet is grappling with issues like excessive generation of greenhouse gases and global warming. The adverse effects of climate change impacts physical infrastructure and efficiency of processes in the manufacturing industry across sectors, including Oil & Gas. The drastic results could lead to probable damage to assets, interruption in production, disruption in the supply chain, availability of water, employee health, among others.

We firmly believe that centring the business on sustainability leads to economic, environmental

and social progress. Our approach is to go beyond environmental compliance and achieve best-in-class performance. Our actions are guided by our Board-approved policies on environment and sustainable development.

We realise the impact of our operations in the surrounding environment and, therefore, have systems to manage our ecological performance and maintain a relentless focus on operational excellence.

Our best-in-class management systems focus on the Health, Safety & Environment (HSE) aspects of the business. Our major installations are certified with the environmental management systems.

Our Corporation has adopted a well-defined process for managing its risks on an ongoing basis and for conducting the business in a risk conscious manner in line with our objectives and regulatory requirements. Further, HPCL participated in a comprehensive study on 'Climate Change Risks and Preparedness for Oil and Gas Sector in India'. The outcomes of the study have provided direction for incorporating adaptation and mitigation measures to counter probable impacts of climate change on its infrastructure, operations as well as upcoming projects.



↗
A glimpse of bio-diversity at our locations

Environment Policy

The Corporation is committed to conduct its operations while staying aligned with the conservation of the environment and economic development of the community. Its aim is to sensitise our people about the importance of conservation of environment by ensuring equal participation. The employees are encouraged to focus on leveraging operational best-practices, philosophy and training which are better suited for the environment.

Objectives of this policy are:

Adopt environment sound operating systems, practices and procedures.

Strive to progressively bring about an improvement in the environmental performance of our facilities by adopting eco-friendly techniques/processes for optimal use of energy and to reduce hazardous emission and wastes.

Establish procedures and devise suitable method for disposal of toxic, other hazardous waste and scrap.

Create environment awareness amongst its employees and develop programmes for environment protection.

Comply with the relevant statutory rules & regulations and devise appropriate standards on other cases wherever required.

Maintain highest standards of vigilance and preparedness to respond to emergencies supplemented with mutual aid of neighbouring facilities and Government agencies.

Endeavour to associate with and support R&D on environment by Government agencies and reputed research institutes.

Programme reviews and evaluation to measure progress of compliance with the policy.

Conducted a mega awareness campaign across various locations to spread the World Environment Day message on the theme of **'Beat Air Pollution'**

Environmental Performance

MATERIALS MANAGEMENT

As a responsible corporate, we are aware of the impact created by natural resource consumption. We recognise that it is our duty to reduce the environmental stress on the planet by adopting sustainable solutions to growth. We believe in the optimum utilisation of resources across various steps of our supply chain through resource conservation initiatives and adoption of the latest technology, besides recycling, reuse, process optimisation and innovation among others.

Material Consumption at Refineries

Materials	Unit	Total
Additives, Chemicals and Catalyst	MT	23,395
Caustic	MT	9,617
Liquid Nitrogen	MT	6,170
Lube Oil	KL	257.5
Greases	MT	5
Transformer Oil	MT	10.2
Dry Chemical Powder	MT	8.3
Cotton Waste	MT	5.5
Foam	KL	52.9
Corrosion Inhibitors	KL	35.5
Filters	Nos.	6,495
Rubber Hoses	Nos.	401
Batteries	Nos.	1,521
RLNG	MT	20,163
Metal Containers	Nos.	445
Hydrogen	MT	841

Associated Material Consumption at Refineries

Refrigerant	MT	0.5
-------------	----	-----

Recycled/Reused Materials in Refineries

Materials	Unit	Total
Slop	MT	224

Recycled/Reused Materials in Marketing Locations

Materials	Unit	Total
Lube Blending Interface (Oil)	MT	767

Material Consumption at Marketing Locations

Materials	Unit	Total
Bottling Cylinders	MT	1,79,787*
Brass Valves	MT	1,501*
Additives and Chemicals	MT	22,685
HFHSD	MT	3,813
Pressure Regulators	MT	2,131
MTO	MT	1,121
O-rings	MT	41*
Dry Chemical Powder	MT	60.9
Lube Oil and Greases	MT	60.3
Conkote	MT	732
Cotton Waste	MT	26.2
Caustic	MT	17.32
Base Oils	KL	6,18,922
Paint & Primer	KL	980.4
Corrosion Inhibitors	KL	3,11,738
Foam	KL	175.2
Blue Dye	KL	12,848
Cartons	Nos.	53,41,876
Plastic Seals and Caps	MT	514.10*
Filters	Nos.	1,604
Rubber Hoses	Nos.	3,718
Wooden Pallets	Nos.	3,925
Metal Containers	Nos.	5,09,146
Plastic Containers	Nos.	4,67,93,952
Glass Containers	Nos.	155
Batteries	Nos.	635

* Since these materials undergo reuse multiple times (subject to testing) before getting declared as waste, this year we have reported only the quantities of new materials.

Highlights of resource intensity reduction initiatives

- Weight optimisation of containers and barrels leading to substantial savings in material and cost
- Successful completion of trials on sustainable packaging solutions for our existing packages like monolayer pouch for lubricants, recycled HDPE plastic for HDPE, among others
- Successful implementation of electromechanical locking system at 13 POL locations and work in progress at additional locations, leading to reduction in material consumption and inventory of locks

ENERGY PERFORMANCE

Energy is becoming a prominent driver of economic development. By the nature of our business, which is to provide energy to millions, we are highly focused on energy efficiency in our operations while fulfilling the energy demands of the nation.

We continuously measure and monitor our energy consumption. We have been optimising our processes to minimise energy consumption by adopting best practices and energy-efficient technologies across our refineries and marketing locations.

Direct Energy Consumption at Our Refineries and Marketing Locations

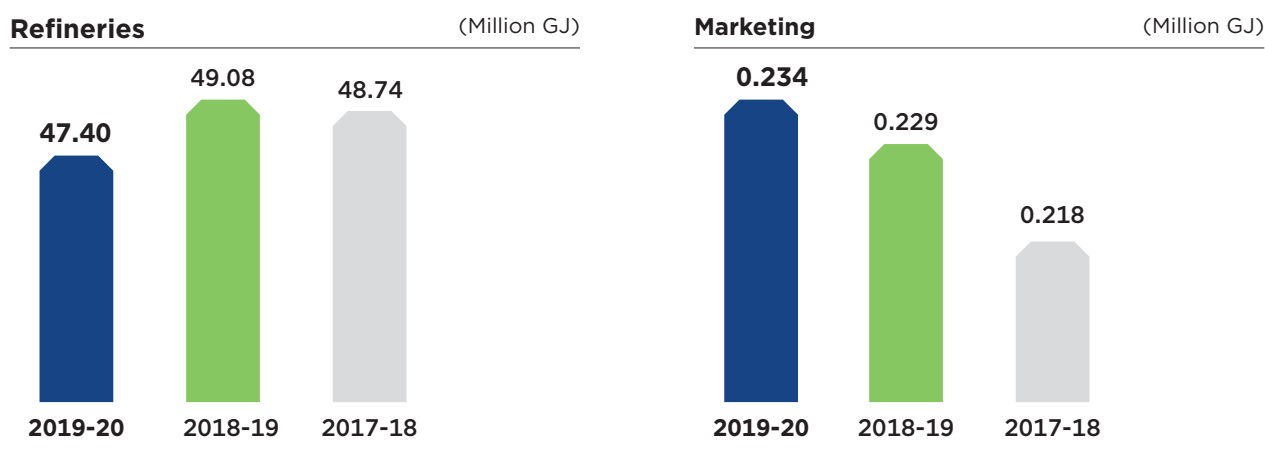

Indirect Energy Consumption at Our Refineries and Marketing Locations

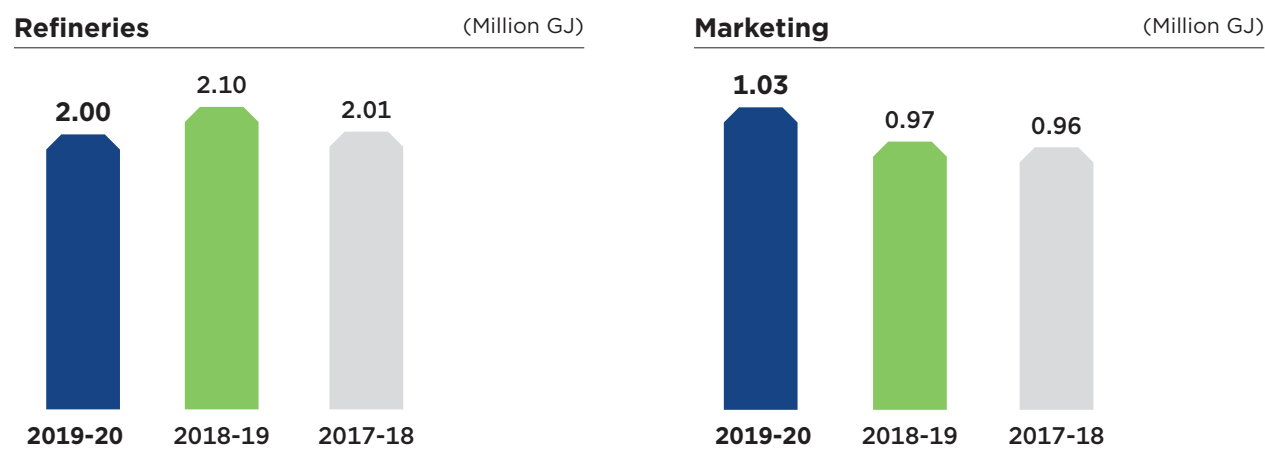

Local Conversion factors are used for energy consumption calculations.

Energy Consumption Outside the Organisation

This year, we estimated 8.59 Million GJ of energy consumption towards product movement of Marketing SBUs. (*Energy consumption accounted for product movement by road).

Environmental Performance

Energy Intensity (Direct and Indirect) at Our Refineries and Marketing Locations

Energy Intensity - Refineries*

(GJ/MT)

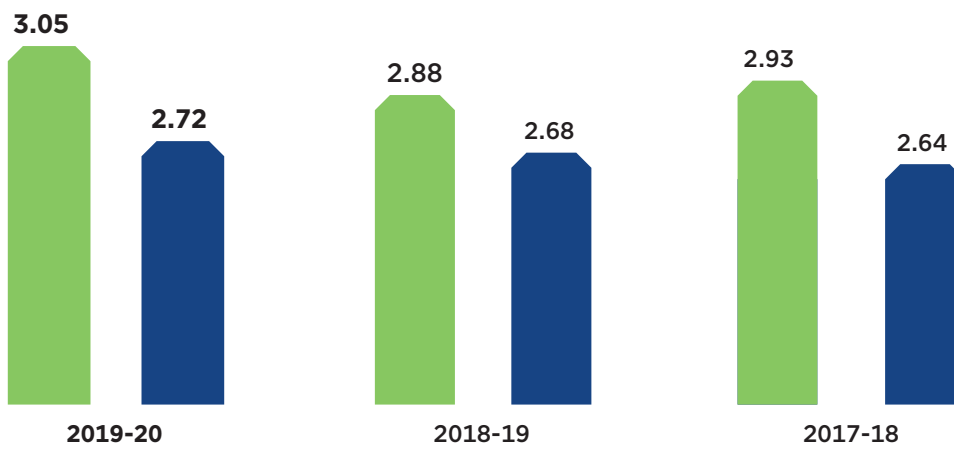

*For Refineries: per MT of Crude processed

■ MR ■ VR



Flame proof LED lighting at tank truck loading gantry at one of our POL locations

Energy Intensity - Marketing* (GJ/MT)

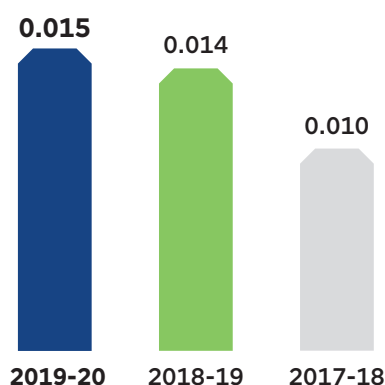

*For Marketing: per MT of product throughput

Energy Conservation at Refineries

Energy conservation is a key focus at our refineries. We are consistently working towards developing and implementing strategies for efficient use of energy in our refineries.

Both the refineries completed the Solomon Associates (SA) benchmarking exercise of CY 2018 and have shown progressive improvement in EII over the last four bi-annual cycles. Mumbai Refinery showed improvement in EII from 117 to 105.3 and Visakh Refinery showed improvement from 116 to 104.9.

The major component of our refineries' operating cost is energy cost and therefore refineries accord highest priority to energy conservation. Bureau of Energy Efficiency (BEE) has extended PAT (Perform, Achieve and Trade) cycle II programme to the petroleum sector, which is being coordinated by CHT for Indian refineries. Both HPCL refineries along with other PSUs are actively participating in this process. Monitoring and verification audit was completed by BEE.

We made a capital investment of ₹3.67 Crore on energy conservation equipment in the refineries during the reporting period.

We evaluate and determine areas for substantial energy savings and execute both long-term and short-term strategies towards energy conservation. The energy conservation measures undertaken by our refineries during the year 2019-20 have resulted in savings of approximately 25,586 Standard Refinery Fuel Tonnage (SRFT).

25,586 SRFT

Energy savings in refineries

Major Energy Conservation Measures

Mumbai Refinery

- Ceramic coating in HGU Reformer
- HGU-installation of E-17 exchanger
- Power consumption optimisation in PDU compressor (C302)
- Improvement in furnace efficiency of Solvent Extraction Unit in Lube Refinery
- Power recovery through back pressure steam generator

Various energy conservation measures undertaken by Mumbai refinery resulted in savings of ~ 10,617 SRFT.

Visakh Refinery

- Integration of Merox Amine Regeneration Units (ARU) and MS Block ARU commissioned
- Hot separators in DHT implemented as part of revamping of DHT unit
- Addition of rows in the convection section of NHT heaters
- Amipur system installed in MS block units
- Various energy conservation measures undertaken by Visakh Refinery have resulted in savings of ~ 14,969 SRFT

Energy Conservation at Marketing Locations

We periodically identify potential areas for improvement as part of our energy conservation strategies. Measures for the identified areas upon implementation aid in achieving significant energy savings.

During the reporting period, our marketing locations took several initiatives to achieve energy savings. Few of initiatives are mentioned below:

- Installation of energy efficient equipment and deployment of latest technologies at locations
- Installation of energy monitoring system
- Conducting periodic energy audits to identify energy saving opportunities
- Replacing conventional lighting with LED lights
- Educating stakeholders on energy conservation

Environmental Performance

MANAGING OUR CARBON FOOTPRINT

The Earth is witnessing unprecedented temperature changes and other effects of climate change year after year. The primary reason for this crisis is Greenhouse Gas (GHG) emissions. Often society’s priorities on development influence GHG emissions.

Businesses across the globe are becoming increasingly aware of the emissions caused by them and are trying to adopt processes through innovation and incorporation of various solutions to reduce and mitigate the impact caused by GHG emissions. We constantly evaluate our processes and methodologies in this respect.

Scope 1: Direct GHG Emissions at Our Refineries & Marketing Locations

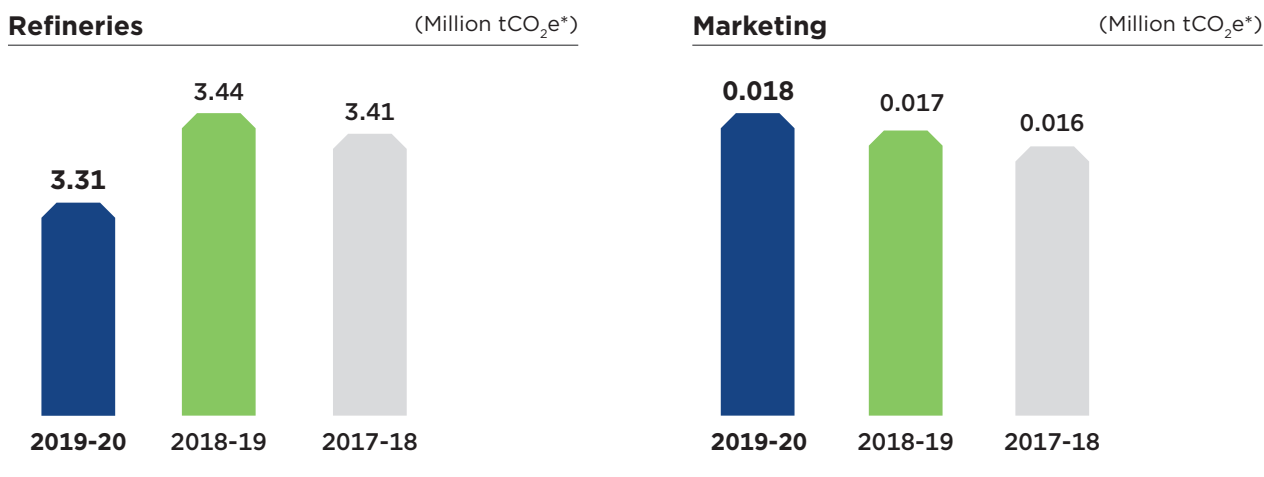

* Includes CO₂ and CH₄

Scope 2: Indirect GHG Emissions at Our Refineries & Marketing Locations

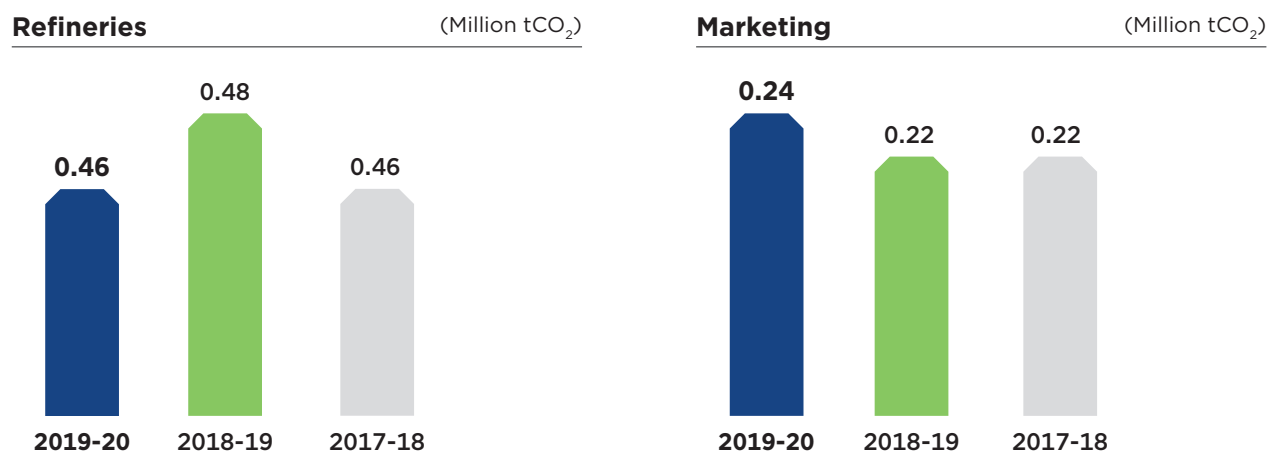

Estimation of Scope 3 Emissions

This year, we estimated 0.0041 Million tCO₂, 0.000054 Million tCO₂, 0.00327 Million tCO₂ towards domestic business travel by air, rail and commute of our employees, respectively. The emissions due to product movement of marketing SBUs is estimated at 1.04 Million tCO₂ (includes scope of transportation by rail, road and ship).

The quantum of emissions due to product movement (rail, road and ship) for 2018-19 is being restated as 0.95 Million tCO₂ due to recalculation.

GHG Emissions Intensity at our Refineries and Marketing Locations

Refineries*

(tCO₂e/MT)

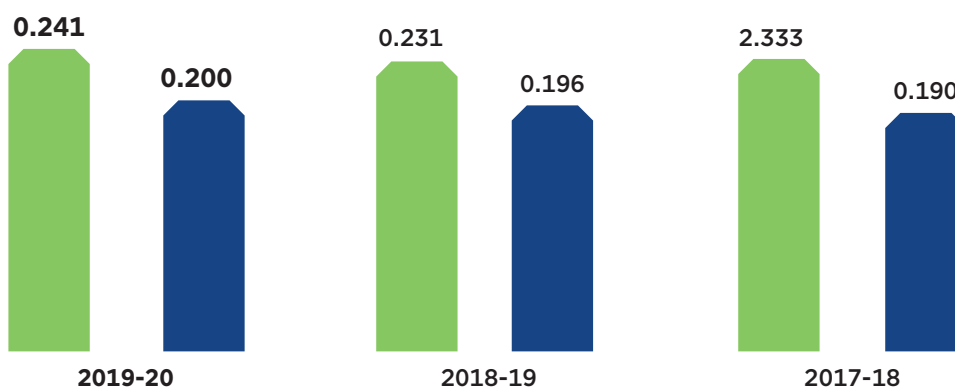

*For Refineries: per MT of crude processed

■ MR ■ VR

Marketing*

(tCO₂e/MT)

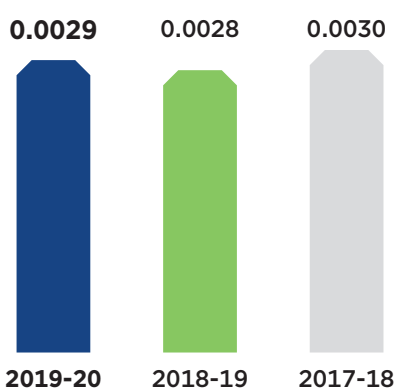

*For Marketing: per MT of product throughput

Significant Air Emissions for Refineries in 2019-20*

Emission Type	Unit	Total
Suspended Particulate Matter (SPM)	MT	379
Nitrogen Oxides (NO _x)	MT	3,839
Sulphur Oxides (SO _x)	MT	4,013

* Measured Values

The standards, methodologies and assumptions (based on operational control) used for the purpose of our calculations were obtained from the Intergovernmental Panel on Climate Change (IPCC), Guidelines for National Greenhouse Gas Inventories - 2006, the IPCC AR4 Fourth Assessment Report, (with consideration of 2019 Refinement to the 2006 IPCC Guidelines for National Greenhouse Gas Inventories), Central Electricity Authority (CEA) - CO₂ Baseline Database for the Indian Power Sector, Version 15.0, Dec 2019 and India GHG Programme, Version 1, 2015 (emission factor for air and rail transport).

Environmental Performance

Pollution Control Measures and Other Environmental Initiatives

Mumbai Refinery

- Achieved full-scale compliance in pollution parameters on stack emissions, hazardous waste disposal and statutory filings
- Completed and commissioned revamp of IETP VOC system for enhanced capacity and efficiency
- Established connectivity for CEMS, CAAMS and EQMS analysers with 100% connectivity to CPCB/MPCB servers
- Installed and commissioned Particulate Matter (PM) analysers for the remaining 17 stacks in compliance with OCEMS guidelines of CPCB and real-time data being transmitted to CPCB/MPCB servers

Visakh Refinery

- Established real-time transfer of stack, CAAMS and liquid effluent analyser data to APPCB server
- Procured VOC monitor for effective monitoring of leaking equipment and timely repair to reduce/eliminate VOC emissions
- Procured portable flue gas analyser for measuring stack emissions and excess oxygen in furnaces/boilers
- Carried out Leak Detection and Repair (LDAR) programme for monitoring and controlling hydrocarbon emissions in the refinery

Marketing

- Procured 46 Crore litre of Ethanol, which resulted in an overall ethanol blending percentage of 4.96%. In addition, HPCL recorded the blending of highest ever quantity (5 Crore litre) of biodiesel during 2019-20
- Achieved pipeline throughput of 21.2 MMT, leading to logistics cost optimisation and green transportation
- Released LOI for setting up 40 new CBG plants with a capacity of 55 TMTPA, taking the cumulative to 51 LOIs with capacity of 76 TMTPA to increase usage of biofuels in the nation's energy and transportation sectors
- Enabled clean energy access for about 2.15 Crore low-income households by providing new LPG connections under PMUY to safeguard health of women and young children

Green Cover

Green cover is an effective tool to maintain the ecological balance. It helps in combating the impact of climate change by CO₂ sequestration. India in its Nationally Determined Contribution committed to creating an additional carbon sink of 2.5 to 3 billion tonnes of CO₂ through additional forests by 2030. We have aligned our sustainability activities with the cause. We have increased our green cover over the years by implementing comprehensive guidelines on green belt development. We have a green cover of over 1,150 acre inside our premises as on March 31, 2020. While increasing our green cover, we focus on growing species which are indigenously found and adaptable in that particular region, with high carbon sequestration potential.

To spread awareness and make tree plantation a mass movement, we observe 'Van Mahotsav' at our locations. During 2019-20, we observed Van Mahotsav at various marketing locations with green belt development projects, planting ~2,000 saplings. Our pipeline SBU planted over 8,000 saplings at its operating locations during the year.



Vanmahotsav - (mass tree plantation) at Ajmer Terminal

HPCL has upgraded its value chain for producing and marketing BS-VI fuels. While the BS-IV fuels contained 50 parts per million (ppm) sulphur, the BS-VI grade fuel has only 10 ppm sulphur content, which will lead to reduction in emissions.

HPCL has launched IMO-2020 compliant Very Low Sulphur Fuel Oil (VLSFO) meeting Residual Marine Grade (RMG) 0.50 specification and ISO 8217:2017 Standard requirements. This fuel also meets all quality guidelines detailed by the International Organisation for Standardisation in its ISO 23263:2019 Standard. This product will help shipping companies respond to the tightening regulation on sulphur dioxide emissions.



Launch of IMO-2020 compliant Very Low Sulphur Fuel Oil (VLSFO)

Environmental Performance

RENEWABLE ENERGY FOOTPRINT

Climate change has increased the impetus on the use of renewable energy. The concern for climate change brings with it an era of exploring and delivering cleaner technologies. We realise the potential and opportunities in renewable energy to solve future energy crisis and limiting present carbon emission levels.

As a responsible Corporation, we are focusing on renewable energy sources and implementing various renewable energy projects at our locations.

Our total wind power and solar power installed capacity is 100.9 MW and 32.6 MWp respectively.

Key Highlights 2019-20

Generated about 18.6 Crore kWh electricity through our wind farms

Started selling renewable energy certificates (RECs) in the Indian energy exchange

Commenced open access electricity purchase for marketing locations and refineries to optimise electricity cost

Installed solar power facility at 1,050 retail outlets

Installed solar power facility with a total capacity of 786 kWp at Ajmer, Gummidipoondi, Panagarh and Aurangabad LPG plants

Commissioned 1.5 MWp solar power plant at MDPL-Palanpur and 0.87 MWp solar power plant at VVSPL - Vijayawada

Commissioned additional solar power plants at POL installations, thereby taking the total installed capacity to 6.56 MWp at POL locations

Increased number of EV charging facilities at retail outlets with a few using a renewable form of energy through Solar PV

Released LOI for setting up 40 new CBG plants with a capacity of 55 TMTPA, taking the cumulative to 51 LOIs with 76 TMTPA capacity

WATER MANAGEMENT

There is nothing more essential to life on Earth than water. Water is not a commodity but a common resource. Both individuals and industries need to adopt water saving techniques and water management principles. The world will not be able to meet the sustainable development challenges of the 21st century – human development, liveable cities, climate change, food security, and energy security without improving management of water resources and ensuring access to reliable water and sanitation services. Consuming water in the most efficient way is the need of the hour.

We have systems in place to measure, monitor and manage our water consumption. We have been identifying opportunities for water conservation. We at HPCL, follow the 4R (Reduce, Reuse, Recycle and Recharge) approach towards water conservation. We have been striving towards making locations 'Zero Liquid Discharge' and conducting water audits at our locations.

We ensure that our withdrawal does not significantly impact water sources. During the reporting period, there were no significant spills or any significant effect on water bodies due to discharge from our operations.

Water Withdrawn by Source at Refineries

Source of Water	Quantity (TKL)
Seawater	90,629
Municipal	9,350
Rainwater harvested and collected for reuse	88
Total	1,00,067

Water Withdrawn by Source at Marketing Locations

Source of Water	Quantity (TKL)
Groundwater through borewell	800
Municipal	351
Tanker	268
Freshwater from other organisation	92
River/Canal water	59
Rainwater harvested and collected	53
Others	13
Reservoir/Lakes	21
Total	1,657

Specific Water Consumption

Refineries* (KL/MT)

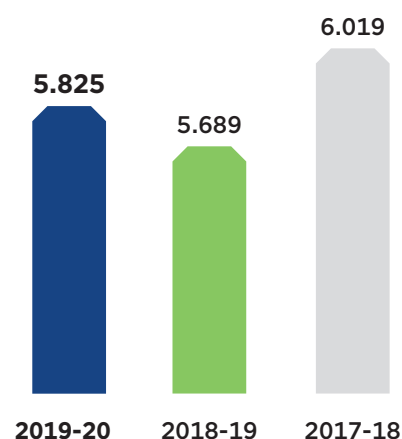

*For Refineries: per MT of crude processed

Marketing* (KL/MT)

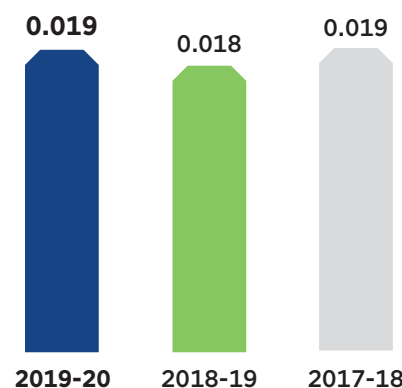

*For Marketing: per MT of product throughput

Environmental Performance

Water Recycled/Reused/Recirculated

Type of Water	Quantity (TKL)
Refineries	
Treated Water from ETP used within Premises	794
Condensate Recovered	1,667
RO Reject Water	874
Reuse of Water in Processes (Bearing Cooling)	57,593
Sub Total	60,928
Marketing Locations	299
Grand Total	61,227
Percentage of Water Recycled/Reused/Recirculated	60.2

Some of our Water Management initiatives

Conducted environmental audits w.r.t. CFO and OISD-GDN-212 for Mumbai and Visakh refineries, respectively

Conducted environment inspections w.r.t. CFO and OISD-GDN-212 at 8 marketing locations

Conducted 10 numbers of water audits w.r.t. CFO and OISD-GDN-212 for exploring 'Zero Liquid Discharge (ZLD)' and 'water neutrality' opportunities at marketing locations

Commissioned online Steam and Water Analysis System (SWAS) analysers for HRSG-III and IV at Visakh Refinery

Capturing rainwater through rainwater harvesting structures at operating locations

Installation of water efficient fixtures at locations, reuse of water in processes and recycling of water through ETP and STPs

Enhancement of employee awareness through contact programmes, newsletters, technical bulletins, among others

Installed and commissioned COD, BOD, TSS and pH analyser at ETP outlet at our Mumbai refinery. Thus, earlier monitoring parameters of Marine Discharge for O&G, flow and pH are now migrated to monitoring ETP outlet for COD/BOD/TSS/pH and real-time data is transmitted to MPCB/CPCB servers

Water Body Augmentation Initiative

The project is implemented in Gummidipoondi block of Thiruvallur district, Tamil Nadu through our CSR initiative.

We rejuvenated the water body by carrying out activities like clearing the bushes, de-silting, deepening, strengthening, trimming and sectioning the area. The outcome of the project was an improvement in the quantum of water storage, and the duration of holding water increased to at least 6 months from 2-3 months. The project will help reduce the runoff water. Apart from that, the groundwater recharge will improve the water table in the entire region, leading to more cropping intensity and enhanced productivity.

The agriculture and allied sector will benefit out of the water body augmentation/rejuvenation interventions in the region. It will also create adequate employment opportunities throughout the year for the land-less and the less privileged within the village.



Augmentation of Water Body in Gummidipoondi block of Thiruvallur district, Tamil Nadu

Environmental Performance

WASTE MANAGEMENT

Waste management methods can have adverse effects on the environment (in particular biodiversity and ecosystems), the climate, and human health. There are environmental challenges associated with waste management at each step, including waste generation, collection and segregation, transport, treatment and disposal.

As a responsible corporate, we have undertaken various applicable measures for each of these steps in the waste management cycle and safeguarding the environment. Our operations generate both hazardous and non-hazardous wastes. We dispose hazardous waste generated in our locations and refineries through MoEF&CC/CPCB registered recyclers or reprocessors as per the statutory requirement. Systems are also in place to handle non-hazardous waste.

We comply with statutory norms and regulations stated by MoEF&CC, CPCB and SPCB.

To support the Swachh Bharat Abhiyan, we constructed and upgraded toilet facilities in schools, hospitals and communities. Across our locations, we are increasing awareness on cleanliness. Activities were conducted involving large number of people from various parts of the country.

Hazardous Waste Generation in Refineries

Type of Waste	Unit	Total
Oily Sludge (including ETP oily sludge)	MT	13,724
Spent Charcoal (including coke)	MT	221
Spent Catalyst	MT	2,909
Spent Resin	MT	30
Insulation Wool Waste	MT	98
E-waste	MT	6.1
Tyres and Other Rubber Scrap (including Hoses and O rings)	MT	16.5
Scrap Batteries	Nos.	1,450
Spent Metal Catalyst	MT	450
Others (Cooling Tower Wood)	MT	100

Non-Hazardous Waste Generation in Refineries

Type of Scrap/Waste	Unit	Total
Metal Scrap	MT	7,251.8
Plastic Waste	MT	47
Plastic Containers	Nos.	12,757
Metal Containers	Nos.	8,329
Scrap Equipment	Nos.	4
Others	MT	21.7

Hazardous Waste Generation in Marketing

Type of Waste	Unit	Total
Oily Sludge (including ETP oily sludge)	MT	784
Paint Sludge	MT	62.8
Insulation Wool Waste	MT	0.6
Oily Soaked Cotton Waste (including gloves)	MT	6.9
E-waste	MT	7.1
Chemical Containers	Nos.	3,895
Scrap Batteries	Nos.	607
Filter Elements	Nos.	1,484
Tyres and Other Rubber Scrap (including Hoses and O rings)	MT	16.9
Used Oil	KL	15.8

Non-Hazardous Waste Generation at Marketing Locations

Type of Scrap/Waste	Unit	Total
Metal Scrap*	MT	18,920
Paper Waste	MT	34.4
Wooden Scrap	MT	82
Plastic Waste	MT	91.1
Plastic Containers	Nos.	40,329
Metal Containers	Nos.	17,396
Scrap Equipment	Nos.	367
Glass Scrap	MT	0.12

* includes scrap from LPG cylinders, self-closing (sc) valves, domestic pressure regulators and miscellaneous items.

HPCL Kanpur Terminal installed bio-methanation plant to convert organic waste into fuel. The output of the converter results in biogas generation of 1.5 kg per day

Waste Management Measures

Refineries

- Oily sludge quantity of 2,500 m³ is undertaken for bioremediation by ONGC-TERI Biotech Ltd. (OTBL) in Mumbai Refinery (MR)
- Online robotic cleaning continuous operation in place for improving API separator separation efficiency and minimising sludge generation in MR
- MR disposed approximately 1,851 MT of hazardous waste and 450 MT of metal bearing spent catalyst within stipulated norms of disposal
- MR processed 160 weathered bitumen drums and 14m³ bitumen
- VR processed 14,723 m³ of oily sludge during the year
- VR disposed off around 803 MT of various hazardous waste materials
- Bioremediation of 302 m³ of low oily sludge completed at VR
- In-situ processing of high oily sludge (3,006 m³) from crude tank was successfully carried out
- Percentage of recycling of products is <5%. Mainly off spec products (slop) generated during crude oil refining as well as during product handling are recycled back. This slop generated is reprocessed for converting to products on a regular basis

Marketing

- Disposal of waste generated through SPCB-authorized Common Hazardous Waste Treatment, Storage and Disposal Facility (CHWT/SDF)
- Deployment of composting pits and organic waste converter machines at various locations to convert organic waste to manure
- Our locations have ETPs and STPs in place for treatment of effluent and sewage water
- Reuse of scrap material



Brief note on progress of ongoing cases pertaining to show cause/legal notices received from CPCB/SPCB:

- CPCB issued a closure notice to HPCL Mumbai refinery in December 2018 due to non-compliance w.r.t. connectivity of few real-time analysers to CPCB servers. HPCL achieved the desired compliance by February 2019. CPCB revoked the closure notice in April 2019 and levied compensation charges of ₹25.2 Lakh on Mumbai Refinery for the period of non-compliance w.r.t. connectivity of analysers, which were paid in May 2019.
- In the case before NGT Charudatt Koli & Anr Vs. Sealord Containers & Others, the petitioners alleged that Industries in Mahul, Mumbai are polluting and creating health hazard to the nearby residents. NGT Pune on 18.12.2015 directed MPCB to prepare action plan to control pollution and conduct health assessment study; etc. HPCL has complied with the directions of MPCB, issued pursuant to NGT Orders. In the execution application filed by petitioners, the NGT directed amount of ₹2.5 Crore to be deposited with CPCB for restoration of environment. On challenge, the Supreme Court vide order dated 08.05.2019 dispensed with this amount and directed CPCB to consider the explanation of HPCL before it arrives at its conclusion. As per NGT directives, HPCL submitted detailed action plan to improve environment beyond compliance. NGT directed CPCB to carry out environment damage assessment study through expert agencies. Accordingly, NEERI submitted its final report to CPCB which, in turn, submitted to NGT. Further hearing is pending.
- CPCB issued circular dated 12.02.2016 directing OMCs to install Vapour Recovery System (VRS) at all retail outlets with sales of 300 KL/M of petrol or more, in cities with million plus population. Petition filed before the NGT for directions to MoP&NG and OMCs to install VRS at all fuel stations, distribution centres, terminals, railway loadings/unloading facilities and airports in the NCR region. NGT disposed the matter by an order dated 28.09.2018 directing OMCs to ensure installation of VRS giving timelines. OMCs filed a civil appeal before Hon'ble Supreme Court of India and the Supreme Court vide its order dated 14.02.2019 extended the timelines for installation of VRS upto 31.03.2020 for outlets selling > 300 KL/M and up to 30.09.2020 for outlets selling < 300 KL/M. While VRS has been installed at outlets, the pre-commissioning and testing checks on VRS at installations involving foreign parties could not take place due to the COVID-19 restrictions. Hence, an application was moved before the Hon'ble Supreme Court for time extension and on 08.04.2020, the Hon'ble Supreme Court allowed HPCL's application and granted further 6 months' time to complete the activities.

Environmental Performance

GREEN OUTLOOK

Our Corporation has been adopting and promoting green processes into its operations. A testimony of the same is the adoption of the GreenCo rating system promulgated by the Confederation of Indian Industry (CII).

HPCL has the distinction of being the first PSU and company in the Oil and Gas sector in the country to adopt GreenCo rating. In the year 2019-20, our four marketing locations were certified with GreenCo Rating.



Our Calicut ASF is the first ASF in the Oil and Gas sector in the country to adopt GreenCo rating.

HPCL was conferred the 'IGBC Green Championship Award' for green building designs, promoting Green Complex and development of Green belt at locations across the country.

DRIVING SUSTAINABILITY THROUGH START-UPS

We are focused on promoting Start-ups and nurturing entrepreneurs in the Oil & Gas sector, collaboration with other business entities on fuel and non-fuel businesses. The initiative is under the aegis of the ‘Start-up India’ scheme, which is a flagship initiative of the Government of India, intended to build a strong ecosystem to nurture innovation and Start-ups in the country, drive sustainable economic growth and generate large-scale employment opportunities.

We collaborated with and supported the following initiatives in the Start-up space to promote environmental sustainability.

Harvesting Solar Energy for Household Cooking

We are supporting a Start-up engaged in the development of a revolutionary compact thermal storage-based solution, which aims to satisfy all energy needs for household cooking with superior experience and performance than gas and electric cooktops. With over 10 patents filed on concept, technology and process, the Start-up has already achieved the critical milestone of developing an intermediate prototype and is now working towards developing a final prototype, which shall be used for further testing by laboratories and institutions before commercial production.

Aggregation and Utilisation of Surplus Biomass

One of the Start-ups funded by HPCL is actively engaged in reconstructing the agriculture supply chain for assured and efficient aggregation and supply of surplus biomass. The project includes establishing POC for Centralised Threshing Centre (CTC) for aggregation of biomass and cane-thumper-based cane harvesting technique using diversified cropping pattern. The milestones achieved include design, fabrication and testing of a hydraulic baling press to compress biomass into bales. The Start-up is actively engaged with agriculture universities to form strategic partnerships for harvesting and post harvesting work for their research projects.

Reducing Plastic Pollution

Funded by HPCL, this Start-up provides an alternative to plastic straws in the form of leafy straws that are 100% organic, biodegradable drinking straws made of fallen and dried palm leaves. They require no external coating, stay intact in liquid for hours and have a one-year shelf life. The Start-up has patented solutions for regular, thick shake, cocktail and tetra-pak forms for leafy straws. By converting the fallen dried palm leaves waste to useful leafy straws, it also helps reducing air pollution. The Start-up also provides sustainable work and business to women’s self-help groups, small farmers and other micro entrepreneurs.

2G Bioethanol from Agricultural Biomass

A Start-up in the process of onboarding by us is engaged in the development of 2G bioethanol from agricultural biomass like corn cobs, rice husk, duckweed and so on. The Company holds a patent for the process of producing biofuel from Laminacae-duckweed/horseweed. The firm is currently pioneering continuous process to produce bioethanol, which is a very unique technology in the country today. The Start-up is currently collaborating with reputed institutions in design and developing this continuous process of scaling up technology.

HPCL has plans to expand its business operations in the EV ecosystem, which includes providing EV charging facilities & Battery Swapping Stations at its Retail outlets as well as supporting Start-ups working in the field of battery technology & E-mobility. We are closely working with leading EV OEMs/ Discoms/ EV Charger manufacturers/ Fleet aggregators and Research Institutions to promote green initiative by providing state-of-the-art EV infrastructure at our Retail outlets.

So far, HPCL has installed EV Charging facilities at 34 Retail outlets across 8 Cities with 4 Million plus population and across major highway corridors.

HPCL is also setting up pilots for Battery Swapping Stations for 2/3 Wheeler EVs at Mumbai & Delhi, in active collaboration with leading EV OEMs.

In the field of Energy Storage, HPCL is actively looking for batteries beyond Lithium with the help of its R&D centre and working on development on new technology for Lithium ion cell batteries.

PEOPLE PERFORMANCE

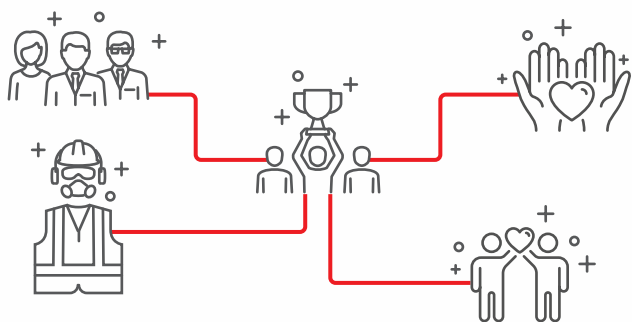

- 79 Team HP
- 81 Talent Acquisition
- 82 Enhancing Competencies
- 88 Performance Management
- 88 Motivation through Recognition
- 90 Employee Engagement
- 92 Employee Welfare
- 92 Human Rights
- 94 Safety at HPCL
- 99 Hale and Hearty HPCL
- 101 Asset Security





A large, colorful backdrop for an event. On the left, it features the HP logo, a stylized graphic of three runners in blue, yellow, and red, and the text "Delivering Happiness". Below this, it reads "ANNUAL INTER SCHOOL ATHLETIC MEET - 2020" and "MUMBAI REFINERY". On the right side of the backdrop, there are several circular logos, including "CLUB HP" and "LUBRICANTS".



People Performance

DEVELOPING STELLAR PERFORMERS

When people with diverse backgrounds and skills come together with a common purpose and value system, they can turn dreams into reality. Our 'HP FIRST' mantra is the common thread, which binds all HPites together to create a formidable force with a focused approach.

We believe that our people have a big role in the success of our strategic business objectives. Developing, empowering and retaining value driven, high-performing employees with the right skills is critical to maintaining our success in a dynamic business environment. Our Human Resources Department supports the business operations and helps enhance performance parameters for each employee. Our HR policies help employees develop their personal and organisational skills, knowledge and abilities. In order

to acquire, develop and retain a superior workforce, we focus on diverse facets of human resource development, such as leadership development, capability building, employee engagement, career development, performance management, coaching, mentoring and succession planning. Our culture is that of empowerment and we work together to unlock each other's full potential allowing excellence to become a way of life.



Some members of our Mumbai Refinery team

TEAM HP

HPites come together from different parts of India, creating a vibrant culture in our Corporation. This pool of multiple talents is a major contributor to the innovation, creativity and zeal that are propelling our growth. A diverse workforce has its own advantages as it brings a lot of different perspectives to the table. As an employer, we provide equal employment opportunities for all. We operate as a cohesive team and treat each other as a family. We are a family of 9,696 people as of March 31, 2020.

Workforce Matrix Basis Region, Age and Gender 2019-20

Number of Employees Region-wise

Employee Category	Senior Management	Middle Management	Junior Management	Non-Management	Total
North Zone	23	168	420	273	884
South Zone	4	108	192	218	522
West Zone	17	201	472	732	1,422
East Zone	5	129	252	265	651
North West Zone	5	105	271	184	565
North Central Zone	7	83	249	114	453
South Central Zone	19	218	450	450	1,137
Corporate HQO	112	246	365	168	891
Marketing HQO	72	206	247	71	596
Mumbai Refinery	25	180	404	796	1,405
Visakh Refinery	27	146	470	527	1,170

Number of Employees by Age

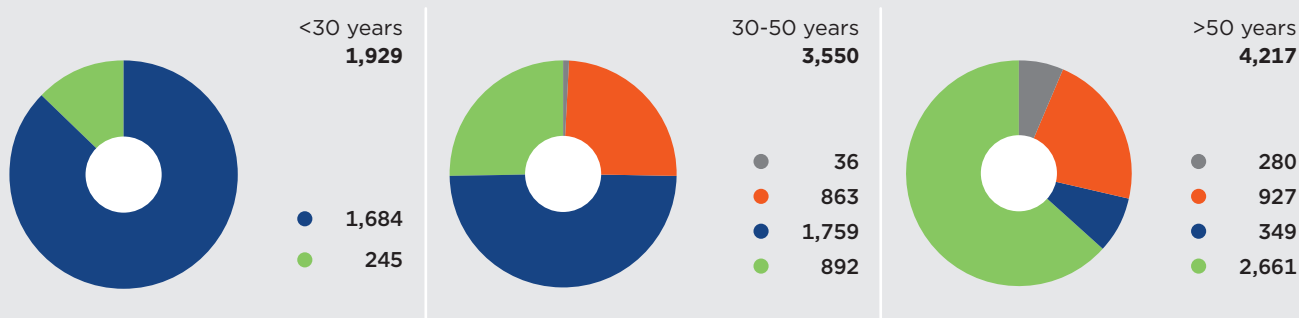

Number of Employees by Gender

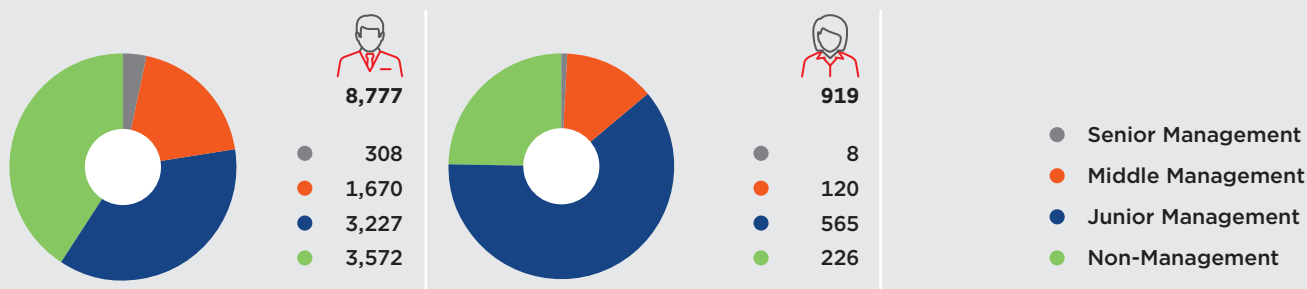

People Performance

Employee Turnover Statistics*

Employee Category	Senior Management	Middle Management	Junior Management	Non-Management	Total
North Zone	2	8	9	25	44
South Zone	1	11	7	29	48
West Zone	1	16	20	80	117
East Zone	0	5	9	36	50
North West Zone	0	3	18	9	30
North Central Zone	0	0	10	11	21
South Central Zone	2	13	12	37	64
Corporate HQO	11	24	11	19	65
Marketing HQO	8	5	8	12	33
Mumbai Refinery	3	11	21	47	82
Visakh Refinery	1	13	14	33	61

*Includes retired, resigned, terminated employees and those who have passed away during the reporting year

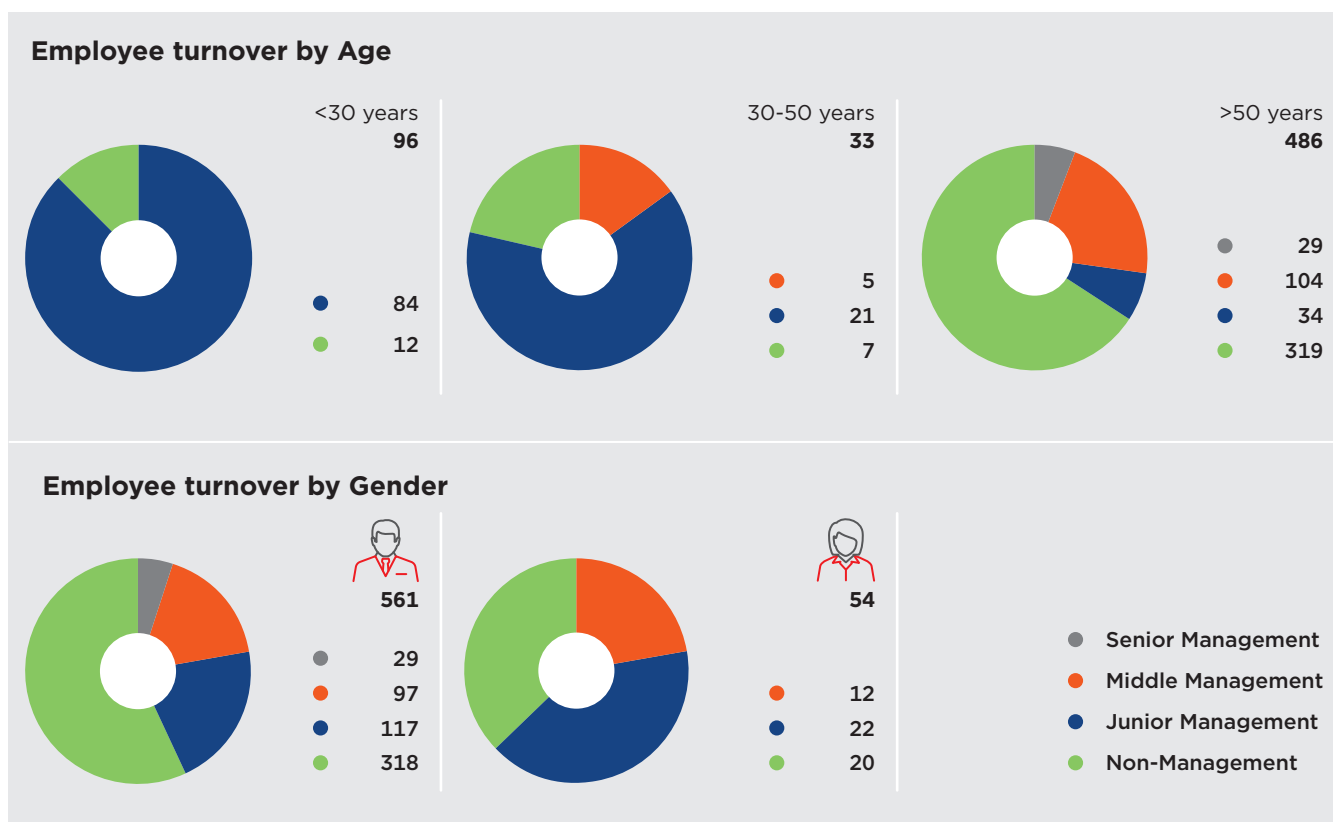

Contract workforce is engaged through contractors for non-core activities at HPCL locations. The number of contract workmen engaged across locations/units of HPCL under various contractors is 42,397 during 2019-20; 15 workmen are on casual basis. The numbers of permanent and contractual/casual workforce are derived from internal monitoring systems.

TALENT ACQUISITION

HPCL recruits highly motivated individuals who share our vision, values and commitment to strive for business excellence and deliver in a challenging business environment.

HPCL's strong brand presence and resonance across India's top institutions in different domains helps us attract quality talent. We adopt a fair, objective, structured and reliable recruitment process that helps identify and attract talented individuals with a passion to excel. Recruitment generally happens at the entry level. However, recruitment at the Middle Management and Senior Management levels is done from external sources as per Corporation's requirement. These recruitments are restricted to positions requiring specialised skills.

A focus on encouraging and achieving diversity in our recruitment processes helps us acquire talent from different backgrounds, gender, caste, origin, among others. In the past, we have actively recruited people from other backward classes, SC/ST and differently-abled individuals and aim to continue creating job opportunities for the underserved sections of the society in the future as well. We conduct special recruitment drives to identify differently-abled candidates for potential roles across the organisation. Irrespective of the varied cultural backgrounds, all new incumbents are treated equally and given equal opportunities to learn, grow and perform. We have fair and transparent policies laid down to protect the interests of our employees.

Samavesh

We understand the anxieties, challenges and hurdles individuals face when joining a new organisation. Our flagship induction programme, 'Samavesh' with activities designed to enhance smooth transition from college to corporate for the new joiners continued during the year. This programme integrates new hires with the ethos of the Corporation at a professional, personal and cultural level.

The year saw the induction of 39 new officers in two batches in Samavesh conducted at HPMDI, Nigdi. This year's Samavesh was enriched by:

- Courses on 'HP Academy' and online learning of NEEV course developed by IIT Bombay customised to HPCL requirements.
- 'HP FIRST' value orientation session using innovative board game based on appreciative inquiry methodology.
- 'HP AVALOKAN' - An overview session using innovative board game designed internally to help participants connect with the entire value chain of HPCL.

Recruitment of Technicians at Mumbai Refinery

This year, 112 technicians were recruited by conducting a Computer Based Exam (CBT) and a skill test. Practical physical tests, indigenously designed by a team of engineers and doctors at the Mumbai Refinery, to test the overall physical and technical skills were introduced.

People Performance

ENHANCING COMPETENCIES

Being a value-driven, employee friendly corporate, we focus on ensuring consistent and quality engagement with our employees, retaining high performing talent and providing better avenues for our employees to build and grow lasting careers at HPCL.

Our employees being the mainstay of our growth story, we have in place targeted interventions to continually strengthen the pillars of our business. In an increasingly dynamic and uncertain business environment, characterised by technology integration, evolving work culture, among other factors, the core jobs in the Oil & Gas industry have undergone a transformation. In order to achieve our strategic objectives, our people must be equipped with contemporary domain knowledge, skills and attitude, which contribute to our future-readiness. Our employee engagement initiatives, training and development programmes enhance the skills of our employees and motivate them to perform better. These programmes are conducted by internal as

well as external faculties to meet the requirements of job roles and for professional development. These interventions ensure that employees are aware of their personal and company obligations at the workplace, safety and environment standards, and the industry and international standards.

With an impetus on encouraging digital transformation in HPCL, our Capability Building Department dedicated the year 2019-20 to enhancing the digital experiences of our employees while delivering quality resources for learning and development.

Our well-structured and categorised training programmes comprise the following:

Functional/Technical Trainings: Functional trainings are aligned to SBU specific requirements and functional needs of a particular job category. These trainings aim to bolster the basics and equip employees with the latest developments in their functional areas.

Behavioural Trainings: Behavioural trainings are aimed at developing behavioural competencies of employees and imparting skills to build interpersonal relationships, enhance communication and develop engaging attitudes and productive emotions.

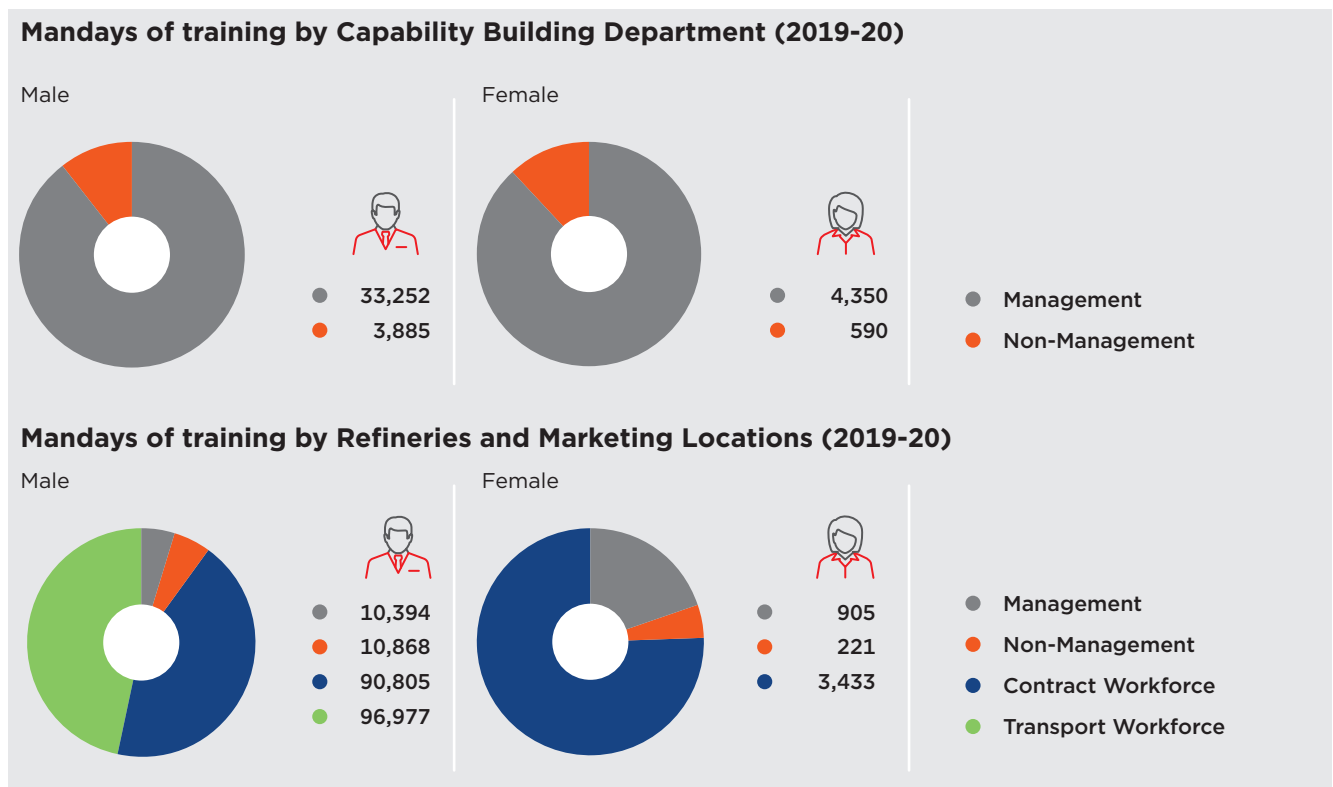

Over the years, we have designed and executed numerous technical and behavioural training programmes for various cadres. Based on the success feedbacks, such programmes are replicated conceptually every year, while new programmes are also devised in accordance with evolving requirements.

Learning and Development Initiatives in 2019-20

Interventions for Senior Management Vasishtha

An exclusive platform for the Executive Directors of our Company that aims to create a heightened sense of self-awareness and accomplishment. One of the avenues provided by Vasishtha is exposure to the episodes of learned and eminent personalities across diverse fields like Spirituality, Space, Science, Sports, among others.

During 2019-20, our Executive Directors interacted with the 'Flying Sikh', Shri Milkha Singh, the torchbearer of Indian athletic prowess. He shared his life lessons and inspired our leaders to achieve their will.

This year, we launched a book titled 'Footprints Etched in Time' - a collection of biographies of our Executive Directors, penned by young HPites, at the hands of our top management.

Project Periscope

The unique talent development intervention 'Project Periscope' for the senior leaders (CGMs, GMs and DGMs) to enable HPCL achieve the strategic objectives as envisioned by the Company continued in 2019-20. In view of excellent feedback and direct impact on performance improvement, this year also, Project Periscope was conducted. The intervention facilitates participants in understanding-self, making necessary improvements through executive coaching, integrated with action learning projects based on personal stretched targets in line with T20 strategy.

Advanced Management Programmes

We nominate senior executives to advanced management programmes having Indian and foreign component for imparting exposure to renowned faculties and apprise them of latest global technological advancements.

We conducted advanced management programme for senior leaders through MDI Gurgaon, SCOPE & IIM Calcutta, ASCI - Hyderabad, IIM Indore and IIPA, Delhi.



7
'Flying Sikh' Shri Milkha Singh being felicitated at Vasishtha event

People Performance

Interventions for Middle Management

Ecosystems based Interventions

We devised and implemented multiple interventions focused on business ecosystems to provide our workforce an edge in the dynamic and competitive business environment:

Kshitij

Aimed at strengthening the sales ecosystem of the Lubes SBU, this programme is designed to enhance stakeholders' capabilities through scientific inputs, tools and templates and aid in sales processes. Its major objectives include creating a sales pitch using a value proposition framework, learning the constructs of negotiations, implementing them using the negotiation planner and understanding the pre-requisites of channel management to influence channel partner outcomes.

During 2019-20, we organised multiple engagement programmes covering our 260 Lube Distributors, 99 CFAs and channel partner salespersons. A contact programme for Bazaar Lubes Sales Officers, Consumer Lubes Sales Officers and Technical Services Officers was also organised.

Lakshya

'Lakshya' is aimed at strengthening direct sales ecosystem through scientific methodology to aid different sales processes. During 2019-20, we organised multiple engagement programmes for Marketing Managers, Sales Officers of Direct Sales SBU, reinforcing the concepts of Key Account Management, Sales Equation, and new concepts like Sales Pipeline, Forecasting, Inventory Management and Profitability. A 'Think Through Workshop' was organised wherein Regional Managers, Marketing Managers and Sales Officers were invited to present major challenges to the Senior Management. The deliberations led to identification of projects and formation of focused teams to work on them.

Shreshtha

We continued our Managerial development programme 'Shreshtha', for LPG Plant Managers to equip them with innovative techno-behavioural skills. This programme is aimed at improving the engagement levels and creating a culture of safety at their location. This year, 25 new Plant Managers participated in this programme.

Sarvottam

'Sarvottam' initiative for LPG SBU was launched in 2018 after a comprehensive ecosystem diagnosis of LPG Sales team and their stakeholders to assess the present and futuristic needs of the Sales group.

During 2019-20, contact programmes were conducted for 151 Sales Officers through external and internal faculties, which covered various aspects of sales and marketing, including application of latest techniques. For the purpose of knowledge sharing, case stories were developed on topics like safety at the consumer's premises, distributor infrastructure, customer complaints. A specialised workshop was conducted

for 30 officers to provide them an in-depth knowledge of industry-wise alternate fuel conversion, comparison of LPG and other fuels, among others.

A two-day workshop on situational leadership was conducted by M/s Ken Blanchard for Regional Managers from various zones.

We launched a 6-day techno-behavioural programme 'Pramanit', for new and restructured distributors. We also covered 189 participants in 2019-20 at various locations with focus on topics like MDG, Safety, ND, ARB, LPG Accounting, Role of a Distributor, Man-Management, among others by internal and external trainers.

Interventions for Front Line Management

We organised specific programmes for our front line management for honing their technical and people skills:

Learning Ecosystem Development

In order to bring in higher role clarity for role-holder, HR (Marketing) initiated a comprehensive exercise of revising and creating new job descriptions, competency frameworks and learning agenda for all positions under the Marketing Division to enable employees to understand explicitly the knowledge and behaviour expected from them.

The HR team reached out to the role-holders to design the basic documents for 38 unique front-line positions in Marketing SBU, validated the same at various levels across locations and zones and presented them to SBU-wise subject matter experts for validation.

Certified Petroleum Manager's Programme (CPM)

CPM programme aims at holistic development of young and talented engineering officers. Apart from providing the right mix of technical, managerial and behavioural competencies, the programme requires officers to work on projects based on live issues and encompasses the functional and technical knowledge of the entire hydrocarbon value chain. This programme is executed in association with our knowledge partner University of Petroleum and Energy Studies (UPES), Dehradun.



During 2019-20, 116 officers from the Marketing division and Information System division completed the Certified Petroleum Manager (CPM) course.

MBA (Oil & Gas)

In order to enable the young officers to achieve their personal as well as professional aspirations, the educational scheme of CPM has been extended to MBA (Oil & Gas) by UPES. All the officers who have completed the CPM program become eligible for the award of an MBA (Oil & Gas) from UPES, subject to completing the additional credits required under the one year bridge course.

In 2019-20, 82 officers enrolled in the the fourth batch of MBA (Oil & Gas).

Competency Development Program 'NEEV' by IIT Bombay

The 14-week, medium-duration, customised online programme enhances functional and technical skills of young officers. This programme strengthens the capabilities of new officers to deal with various professional challenges. It enables participants to learn specific skills required to prepare and adapt successfully to the dynamic business environment. A total of 489 junior officers spread across all locations and functions completed the program.

HR Path

This initiative was launched with the objective of enhancing the technical competencies of junior HR officers. The content is crowdsourced and the officers design the e-learning modules on various subjects under the mentorship of senior officers.

During 2019-20, 86 e-learning modules were developed by the officers on C&B, CSR, Business, IR, Purchase, among others, which were hosted on the internal portal. An online course was developed on 'Presidential Directives' by roping in an industry expert. The complete development of the course was done in-house.

HR Leaderboards

The HR Leaderboards initiative was launched and upgraded as an online platform to assign tasks between central and zonal HR coordinators. It serves as a forum to recognise officers for their efforts on different work-related tasks based on gamification. It shows officers where they stand in relation to their peers and encourages healthy competition among them.

Capability Building Programme for LPG Operations Officers

LPG SBU and HR (Marketing) undertook a joint initiative to design a capability building programme for LPG plant officers (Operations Officers, Safety Officers, Maintenance Officers) across all LPG plants for a sustainable plant performance and a competent workforce.

A core team comprising subject matter experts and process facilitators designed the competency profiling and framework for the different roles of officers in LPG plants. The technical assessment test was completed

by 96% of the targeted group on the same date and the same time in a proctored environment.

Interventions for Non-Management Employees

We conducted multiple training programmes for non-management employees designed to enhance their technical and behavioural capabilities and help them in handling professional transitions:

- **Project Utkarsh** is a longitudinal and integrated initiative of LPG SBU to bring about significant productivity improvements by fostering collaboration, building ownership and imparting knowledge and skills leading to substantial enhancement in productivity of LPG plants.
- **Project Utkrisht** works to improve the overall efficiency of operations and distribution locations. This project resulted in enhancement across productivity parameters like increase in bay filling rate and decrease in tank truck turnaround time.
- **Utthan** is focused on non-management employees who are promoted from the workmen category to the clerical grade. It targets behavioural and internal process competencies, along with IT orientation and customer centricity for better outcomes on the job.

During 2019-20, Utthan training was conducted in two groups:

- Fresh course covering the employees promoted to clerical during the past three years
- Refresher course covering employees promoted during the past 12 years

Interventions for Extended Workforce

Training programmes for extended workforce are aimed at increasing awareness levels on health and hygiene, personal and operational safety, financial literacy, skills to handle grievances (customer service) and digital transactions.

Prerna

Prerna module is conducted to create awareness on our operations, importance of personal health and hygiene, safety and alertness at the workplace, financial acumen, PF/ESIC rules, work-life balance. 83 Prerna programmes covering 5,451 contract workers were conducted during year 2019-20.

Apprenticeships

Mumbai refinery engaged 162 apprentices for undergoing various training and introduced a practical skill test for trade apprentices for the first time. Introduced External trainings for degree, diploma or ITI apprentices in collaboration with government agencies. We introduced a continuous performance evaluation process of apprentices through quarterly review of learning dairies and vivas for improving engagement levels, monitoring learnings and tracking discipline. Ensured compliance with timely and accurate release of stipend, training procedures and exit formalities throughout the year.

Our Visakh refinery successfully handled the entire engagement process, including interview of graduate and trade apprentices. During 2019-20, we engaged 28

People Performance

trade apprentices and streamlined course to engage 83 graduate apprentices immediately after lockdown is over. We maintained apprentice strength at 150 during the year. Introduced a new trade apprentice segment with a qualifying degree or an MBA.

The Marketing Division conducted pan-India interviews for engagement of TATs and GATs across all zones. 585 trade apprentice trainees and 418 graduate apprentice trainees were engaged across all Marketing zones during the year.

Notable Learning and Development Initiatives

To enhance technical competencies, various technical/functional internal as well as external programmes were conducted during 2019-20.

Technical trainings were imparted through subject matter experts or OEMs on topics like TAS, MBLC, MFM, tank truck fittings, actuator and valves, tank construction, inspection and testing, safety, railway operations and coordination, pneumatic systems, SCADA and LDS, corrosion management, edge computing, process automation through robotics, Industry 4.0 and cognitive technology, planned maintenance - achieving zero breakdown, lubrication in bearing industry, LPG operations and LPG projects.

MoU Target 2019-20

During 2019-20, Capability Building Department imparted 27 online learning programmes against the MoU target of 20 programmes through HP Academy to 1,239 officers to build their technical and managerial competencies for higher positions.

In order to enhance the managerial skills of the officers and make them future ready, HPCL collaborated with various CoE Institutes like IIM Lucknow, IIM Tiruchirappalli, IIT Bombay, XLRI, NITIE, ASCI and ICT Bhubaneswar for conducting one-week duration, medium duration and long duration programmes. During 2019-20, a total of 309 officers (5.19%) have been provided training at Centre of Excellence Institutes exceeding 5% MoU target.

Learning Management System

HP Academy, developed with an aim to inculcate the culture of learning in HPCL, has grown to exponential heights covering more than 90% of the target audience throughout India. HP Academy has 75+ e-learning courses and 85+ e-learning videos. A special online course on COVID-19 was also hosted on HP Academy.

Magzter is also integrated into HP Academy and HP Pariwar, offering a vast collection of 10,000+ e-magazines pertaining to several categories like business, industry, current affairs, finance, science etc. and in multiple languages, including Hindi. Through HP Mini app, employees can access the diverse learning content anytime and anywhere. Various features like upcoming courses, testimonials, and feedback are also a part of HP Academy to enhance the interactivity of the platform.

Similar to Magzter, another online learning resource - EBSCO Online Library is in place for all employees across all SBUs and grades. The library offers a

wide range of e-articles, industry reports, journals and eBooks in an endeavour to support employees in research and self-development across locations. It also provides access to more than 9,300 eBooks on various topics like Business, Management, Science, Engineering, Health etc. Various workshops on how to effectively use EBSCO are conducted at various offices of HPCL across zones.

Virtual Reality (VR) Based Technical Training Programmes

To leverage the advent of Virtual Reality and weaving it with learning objectives, we have set up experience centres at Petroleum House and HP MDI, Nigdi. The experience centre offers SBU specific modules developed to provide empirical learning to the participants. 15 modules on night fire drill, retail outlet safety, equipment operation, among others have been designed to reinforce the SOP based learning by imparting hands-on experience to the employees.

Trainings at HP Technical Capability Enhancement Institute, Talegaon

Our training institute at Talegaon, Pune conducted trainings for O&D Officers, providing them hands-on practical training on terminal and depot equipment (floating roof, TAS, MBLC, and so on) coupled with classroom training on theoretical aspects.

Industry Academia Collaboration

Learning programmes in association with academic Institutions

- Executive general management programmes
- Degree or certificate programmes in technical competencies
- Online medium-duration certificate programmes
- Finalisation of MoU with IIM Amritsar

Notable Initiatives

- Finalised internal trainers and equipped them with training imparting capability through 'Train the Trainer' programme to deliver internal programmes
- Completed development of online Education Growth Plan (EGP) portal and streamlined applications on the online site to encourage self-development of employees for enhanced business competencies
- Conducted workshops on Critical Incident Interview (CII) technique by ESADE, Spain to train our officers who are part of the interview panels for recruitment of new officers in the Company

Special Programmes

- SWAYAM is aimed at developing women leadership and empowerment
- SAKSHAM is our three-day course on Naturopathy and its benefits for senior women executives for improvement in life and health
- Business Simulation Games: Nomination of teams for participation in business games organised by AIMA and NHRDN



↗

HP Management Development Institute - Contributing towards organisational development by imparting knowledge and skills to employees

HP MDI is the premium Management Development Institute of the organisation located at Nigdi, on the outskirts of Pune. It was established with the aim of imparting knowledge and skills and reinforcing positive attitude among the officers, thereby enabling them to contribute towards organisational development through individual growth. The Institute is well equipped with modern training infrastructure to train officers. HP MDI continued to excel in its endeavours to provide quality training to the officers.

Key Sustainability Initiatives 2019-20

- Obtained ISO 9001:2015 certification
- Carried out major renovations in the facility for the benefit of employees
- Launched HP MDI Campus Maintenance App
- Conducted 228 training programmes during the year
- Conducted two batches of Samavesh
- Received 35 awards in various categories in PMC garden award competition
- Commissioned phytoremediation initiative for treatment of sewage wastewater

- Cleaned Pawana Riverbank in Ravet under Swachhta Hi Sewa Campaign
- Distributed cotton bags in the vicinity



↗

HP MDI Team distributed stationery and hearing aids to schools for children with speaking and hearing disabilities in Pradhikaran, Nigdi

People Performance

PERFORMANCE MANAGEMENT

HPCL has established a robust Performance Management System to ensure our employees contribute effectively towards organisational goals and enable the Corporation to make rational and objective promotion and placement decisions. This involves identification of strengths and weaknesses and giving feedback, training, rotational inputs to ensure that the Management positions are manned by personnel having the requisite exposure and competence.

Our HR department is focused on creating high performance work culture through a structured process of goal setting and performance reviews and rewarding employees for their efforts through objective performance assessment. The existing Performance Management System in the Company is based on the balanced scorecard concept developed by Robert Kaplan. Business scorecards were developed at Corporate, SBU/Department levels. These scorecards have been developed based on the four perspectives of balanced scorecard concept:

- Financial or physical perspective
- Customer perspective
- Learning and growth perspective
- Business process improvement perspective

The scorecards formed at the Corporate, SBU or Department levels are cascaded to the individual level

where various Key Performance Indicators (KPIs) and measurement standards to measure each of them have been identified for each position in the Company. These KPIs act as a guide to set individual targets for employees of the Corporation. Standardisation of KPIs is emphasised upon to enhance the robustness of performance management by aligning employees towards common organisational objectives and over 80% officers are covered under standardised KPI templates. The following environment and social parameters are available under the standardised KPI templates, depending on the role and responsibility of the individual:

- Stakeholder Management
- Corporate Social Responsibility
- Energy Efficiency
- Environment Stewardship
- Health and Safety
- Capability Building
- Support towards Sustainability Efforts

During 2019-20, all our employees received regular performance and career development reviews.

MOTIVATION THROUGH RECOGNITION

We understand the importance of appreciating our employees for good work and it has a direct correlation with their performance thereafter. We have several reward and recognition schemes to encourage and appreciate employee contributions. These schemes are institutionalised based on the grades of the employees and include the following: For executives in the senior/middle management, HP ICON Awards have been instituted to identify and recognise People Managers i.e. officers who place the interests of their teams before individual contributions. For officers in the junior management category, HP Outstanding Achievement Awards are to recognise outstanding contributions, while HP Gaurav Awards recognise outstanding efforts among Non-Executive category of employees. HP ICON Awards are given away bi-annually while the HP Outstanding Achievement Awards and HP Gaurav Awards are given on an annual basis.

HP Outstanding Achievement Awards

This year, 54 officers received this prestigious award under various categories for their outstanding achievement during 2018-19. This year, a compendium of the winners' achievements was presented to the top management at the ceremony ensuring that these tales remain unforgettable.



HP Gaurav Awards

We recognised the perseverant roles and inspiring contributions of 116 non-management employees from corporate and Marketing divisions by conferring the coveted HP Gaurav Award. The theme for HP Gaurav Awards 2019 was 'Clean and Green Future' with the tagline: हर कदम, हरदम प्रयास हमारा, हरित भविष्य HP का नारा.



People Performance

EMPLOYEE ENGAGEMENT

Employee engagement activities enable building a sense of belonging among the employees towards the Company which results in delivering superior performance and gaining competitive advantage. Research has shown that engaged employees make additional effort, learn more, and faster, and are more creative. They are emotionally committed to the organisation and its success, thereby making significant impact on the organisation's bottom line. Towards enhancing the engagement levels and building a spirit of togetherness, bond teams, employees and their families, various employee engagement initiatives were conducted during the year. These initiatives were customised towards specific target audience and were instrumental in enhancing engagement levels.

Hamara Pariwar

The Hamara Pariwar portal and mobile application is an online platform through which the entire HP family (employees and their family members) come together to participate in various initiatives and activities conducted, such as:

- Quiz Competition with Winners' Leaderboard
- A Clean Workstation Competition
- Online nominations for employee engagement events
- Publishing leader boards of #HumFitTohHPFit Fitness Challenge
- Free access to online magazine portal

Yuvantage

Yuvantage stands for Yuva Advantage. The young energy coupled with able direction from the Senior Management creates an indomitable momentum that enable our corporation to surpass one milestone after other in the face of ever-growing challenges.

Yuvantage is an engagement initiative targeted at young employees below 35 years of age. This year Yuvantage enrolled many new enthusiastic team members and experienced mentors who laid out detailed plans for events, keeping in mind proximity to nature and activities to inculcate survival skill, team building and individual social responsibility (ISR).

During 2019-20, a total of six Yuvantage-Spark events were held across six cities wherein 279 Yuva HPites participated. Yuvantage team also organised various technical and business events for the HP youth.

Reboot @35+

Reboot@35+ is a platform to operationalise the vision of engaging employees and their immediate families, while fostering and building common interest networks across the Company. It aims at transforming the approach towards life and appreciate the many facets it offers to us, leading to social and psychological fulfilment. This intervention is focused on employees in the age group of 35 and above and has Mindfulness as its core theme. As a part of Reboot@35+, multiple events like All-India Painting Competition, Biz Wiz simulation challenge, Marathon at Mumbai and Jaipur, Cyclothon at Chennai, Pinkathon at Chennai and Mumbai, trekking and outstation trips at Maharashtra and Chennai, Isha Yoga at Lucknow, photography and pot painting workshops at Delhi were organised throughout the year.

GEN Y - 2020

Launched in 2018, GEN Y is a platform for the young officers of the East Zone to network among themselves and with the Senior Management for an opportunity to co-create the future and paint it with their extraordinary innovation and exceptional creativity.

During the year, the third edition of Gen Y (2020), East Zone was organised at Kolkata with the theme 'Carve the Future'.

Spot Appreciation

Towards the objective of strengthening a culture of care, our Mumbai Refinery launched mentoring and spot appreciation with HP Care kit.

Notable Initiatives

To create an enabling, participative, nurturing and winning work culture at HPCL and reach out to the families of the employees and build a stronger bond with the HP Family, employee connect activities (including sports, picnics, movies and so on) are organised on a regular basis at our refineries and marketing locations. Over 100 employee connect programmes were conducted across zones during the year, in which 5,600+ employees and family members participated.

Employee Connect Programmes 2019-20

- Crèche for Mumbai-based employees
- Photography workshops
- Session on financial planning
- Pot painting workshop
- Pinkathon for female employees/spouses of male employees
- Participation in SBI Green Marathon
- Unplugged - a unique programme for Reboot members to re-kindle their relationships and understand the power of staying together
- Step-Out Evenings in the winters
- Session on 'Good Money Habits'
- Garba workshop
- Night Marathon - 'Jaipur By Nite'
- Trekking events for employees
- 'Monsoon Magic' - an outing trip for Mumbai based officers and their family members
- Yoga sessions
- Musical concerts
- Cricket League

HPCL IN LIMCA BOOK OF RECORDS

HPCL made its entry into the Limca Book of Records in three distinct categories.

#Hum-Fit-Toh-HP Fit Challenge, 2018

Fostering an environment that promotes health and fitness, HPCL, organised the #Hum Fit toh HP Fit Challenge, #HFTHPF2018, undertaken by 7,968 participants (employees and their spouses) pan India, a campaign conducted from 1 September to 30 September 2018. Four-member teams were formed to participate in the challenge. The final distance covered by participants was 1,403,758 km and the numbers of steps covered were 2,035,449,557.

Harmonica Challenge: Most people playing the harmonica together

As part of its mega Youth Festival - Yuvantage BLITZ on January 6, 2019 - HPCL set a record for the most people playing the harmonica simultaneously. Our Committee of Functional Directors along with our young officers participated in the record. The music was played by 457 employees on their harmonicas for 6 mins 17 secs at Ramoji Film City, Hyderabad.

Velocipede Challenge: Fastest Assembling of Cycles

HPCL organised the 'Velocipede Challenge', where 313 participants simultaneously assembled 60 bicycles from different segregated components in 45 mins at the Yuvantage 3.0 Grand Finale at Ramoji Film City, Hyderabad, on January 7, 2019. These bicycles were later donated to an NGO to bring smiles to 60 young underprivileged children.



71

HPites participating in the Harmonica Challenge

People Performance

EMPLOYEE WELFARE

We believe that a good work-life balance is key to the overall well-being of employees. We extend support to employees through welfare schemes and benefits in line with our HR policies to help them excel in their personal and professional spheres of life. These include performance-related profit sharing scheme, superannuation benefits, leave encashment, gratuity, during-service and post-retirement medical benefits, benefits for family members of employees posthumously, housing loan, vehicle loan, furniture loan, LFA, transfer benefits, employees' children education loan, computer loan and monthly vehicle allowance and leaves, such as maternity, adoption, surrogacy, child care, paternity leave, among others.

HUMAN RIGHTS

A dynamic and productive workplace most effectively reflects the diversity of humankind. Diversity in the workplace creates a positive impetus on advancement as people of all genders, socio-economic status, cultures and religions share the best of who they are for the well-being and betterment of all. We are an equal opportunity employer and practice zero tolerance towards any kind of discrimination on the basis of religion, origin, gender, status, or other factors and have strict mechanisms to deal with such cases.

We have well established systems and procedures to provide our employees a conducive environment to work and pursue their aspirations in tandem with organisational objectives. Integrity is an important pillar of our strategy and we are focused on conducting business activities in an ethical and transparent manner. To achieve this goal, we conduct regular trainings to generate awareness among our employees on the same.

We believe that our policies incorporate the ten principles of the UN Global Compact (UNGC) and we are committed to upholding internationally proclaimed human rights. To ensure that the human rights of every individual is safeguarded, a robust grievance mechanism has been created to deal with any case of human rights violation. In the reporting year, there were no incidents of discrimination on

grounds of race, colour, gender, religion, political opinion, nationality, extraction or social origin.

Freedom of Association and Collective Bargaining

HPCL strongly upholds Freedom of Association and Collective Bargaining rights. We have had cordial and productive relations with Unions for more than two decades. The fairness and emphasis on transparency coupled with effective grievance management system has resulted in alignment of Unions and employees to the Company's vision. We have formal agreements with trade unions to deal with issues related to wage revisions, productivity improvement, closure/opening of locations, changes in working conditions, health and safety of our employees etc.. During 2019-20, HPCL Trust for Promoting Industrial Harmony awarded 'Shri Raja Kulkarni Samman' to one senior union leader

upon his superannuation in appreciation for the services rendered and outstanding contribution in the area of industrial relations.



Shri Raja Kulkarni Samman

Currently, 94.37% of our non-management employees are a part of unions, which enable them to voice their concerns. Before implementing any management initiatives that affect or concern non-management employees, we engage in constructive dialogue with trade unions to understand their perspectives and arrive at a mutual agreement. During 2019-20, 15 MoUs were signed with various unions pertaining to redeployments, commencement of new shifts, among others for optimum utilisation of non-management workforce. A 'Conclave on Management of Outsourced Services-2.0' was organised for the strategic business units to educate stakeholders on the recent amendments in various labour laws and government policies and formulate an integrated approach to enable the line functionaries to evolve appropriate cohesive strategies in line with the current reality.

We also took proactive steps for contract workforce and ensured contract workers are covered under the Pradhan Mantri Jan Dhan Yojana and Pradhan Mantri Suraksha Beema Yojana. To promote Digital India and a cashless economy, it is ensured that all contract workforce deployed across the Corporation are paid their wages through NEFT. Additionally, various programmes were organised for contract workmen/stakeholders for familiarising them with various modes of cashless payments.

Management Employee Relations Committee (MERC)

An effective grievance redressal system is key to ensuring employee satisfaction and a fair, productive and safe work environment. Our employees have access to the grievance redressal system to settle their individual grievances. The process for handling them through Management Employee Relations Committee (MERCs) has been in place to ensure effective and expeditious handling of grievances. Detailed guidelines for timely grievance redressal through decentralised mechanism for process implementation and online workflow application for effective implementation have been established. Through MERC channel, employees can log in with their grievances in the following matters:

- Performance Management (PM) related matters
- Non-receipt of eligible Compensation and Benefits (C&B) under the Corporation policy
- Other Employee Relations (ER) related matters at the workplace
- The salient features of the same are as follows:
 - E-enabled platform through HP Portal for submission of grievances
 - De-centralised two-tier structure of grievance redressal with MERCs and appellate authority as per the salary grade of the aggrieved officer and the nature of grievance
 - Cross-functional constitution of MERCs to ensure objective grievance handling
 - Systematic review and discussions with concerned person as required
 - The aggrieved officer, if not satisfied by the decision of MERC, may appeal within ten days of the decision of MERC

Prevention of Sexual Harassment (POSH)

To inculcate appropriate workplace behaviour and promote gender sensitisation, 23 workshops were conducted across corporation to educate employees on the provisions of Sexual Harassment of Women at Workplace (Prevention, Prohibition and Redressal) Act, 2013. Internal Complaint Committees (ICC) were also reconstituted in view of reassignment, superannuation, separation or completion of three years as ICC member.

People Performance

SAFETY AT HPCL

HPCL is committed to provide a safe workplace to its employees and contract workforce and safety to the communities wherever it operates. We have rigorous health and safety policies and procedures in place to identify and minimise safety risks related to the Company’s plants, operations and processes. The focus, which our Safety Policy brings to the fore when it says, ‘As an integral part of its business, HPCL believes that no work or service or activity is so important or urgent that safety be overlooked or compromised’, guides us towards our goal of ‘zero incident’.

Safety Management

We take pride in being an important contributor to meeting the energy needs of our nation standing at the cusp of unprecedented development. We offer myriad products, which cater the A to Z of businesses and consumers. As our major hydrocarbon products inherently have a great energy content, we have taken the necessary steps in managing the receipt, processing, handling and delivery of these products in a safe manner. Thus, safety, for us, is an important tool to effectively harness the gifts of nature and contribute to the nation’s development.

Safety is a priority agenda for our top management. Through regular reviews and feedback systems, the top management drives safety across the Company, aided by the HSE Department and safety committees. We focus on formulation, review and enforcement of SOPs, safety in operations, statutory compliance, emergency preparedness, awareness creation and progress review on policy compliance. Our top management periodically reviews progress on compliance of various statutory audits and time bound action plans for redressal of safety observations.



7

Safety pledge during National Safety Week Celebration

Health, Safety and Environment

Our Health, Safety and Environment (HSE) departments function at multiple levels, starting from the headquarters office, including Corporate and SBU level, Refineries, Zonal Offices and at operating level i.e. locations. They work in tandem with projects and operations groups while monitoring and assessing the safety mechanisms through regular multi-disciplinary safety audits, creating awareness among stakeholders, while engaging with government officials on relevant matters and periodic amendments.

Safety Committees

In order to encourage proactive participation and involve the workforce in matters pertaining to HSE, Safety Committees are active at every location, with equal representation of management and non-management employees and more than 50% participation from non-management employees at some locations. These Committees ensure adherence to the Corporation's HSE policies and compliance with regulations, thereby maintaining a healthy and safe work environment. The Committees have an effective mechanism to take feedback from the workforce and address near-miss incidents, thus identifying the gaps and safety risks. It also helps identify the training needs of employees. Additionally, the Committees work towards establishing world-class safety systems. We have online portals to capture near-miss incidents and recognise individuals who provide these inputs.

Emergency Response and Crisis Management

Our safety and security systems at our operational facilities remain on vigil round the clock to identify and manage hazards, risks and emergencies.

We empower our employees through regular training on operational safety, security, emergency preparedness and crisis management. Safety toolbox talks and safety huddles imbibe the safe operating practices and protocols in the workforce, thereby mitigating risks during emergencies. We maintain positive dialogue with our neighbouring communities and involve them in our offsite and onsite mock drills to demonstrate our readiness and instil confidence in them.

In order to protect the workforce, assets and neighbouring communities from any major potential

disaster, we align ourselves to regulatory issues by statutory agencies. The National Disaster Management Authority (NDMA) through Disaster Management Act (DMA), 2015 formulated provisions for better coordination at various levels to ensure effective emergency response. Major incidents require locations to seek additional resources and external help to effectively control the situation. During disasters, as various agencies/officials are involved at each levels of hierarchy, clear role and responsibilities of various levels of the Corporation viz. locations, zonal and corporate level enable better communication and resource mobilisation. Our Crisis Management Plan (CMP) is a Corporate level document with clear roles and responsibilities and communication details of officials of locations, zones, corporate offices and external authorities in case of major incident or disaster, which may be natural or manmade. The CMP aims to provide role clarity at various levels, communication hierarches, handling media and reporting to statutory authorities. This CMP is in addition to location specific Emergency Response Disaster Management Plan (ERDMP). Emergency plans like DMP, CMP and ERDMP are updated periodically.

Process Safety

Process safety, a disciplined framework, which focuses on the concerns of major hazards that may impact safety, cause environmental damage or lead to business losses assumes a major role in HPCL. It deals with the prevention and control of events that have the potential to release hazardous materials and energy. It relies on principles of good design, besides engineering, operating and maintenance practices.

We have integrated Process Safety Management (PSM) in the Corporation's Safety and Environment policies. Effective barriers and established provisions are made for preventing or minimising the consequences of loss of primary containment (catastrophic releases of toxic, flammable, or explosive chemicals) involving our stakeholders. Sound operating systems, practices and procedures equipped with multi-layered protection barriers complying with the highest standards of preparedness to tackle emergencies are maintained on a sustained basis. We also impart awareness and refresher training programmes and conduct compliance audits as a part of the management review and continual improvement process.

Safety Performance

Refinery	Mumbai Refinery		Visakh Refinery		Marketing Locations	
	Employee	Contractor	Employee	Contractor	Employee	Contractor
No. of Fatalities	Nil	Nil	Nil	1	Nil	Nil
Lost time Injury Frequency Per Million Hours Worked	Nil	Nil	0.3802	0.0395	Nil	0.0191
Total Number of Recordable Injury Incident Rate Per Million Hours Worked	Nil	0.2995	0.3802	0.1974	0.4623	0.1526

Notes:

- All above injuries/fatalities are under male category, female category- nil
- The absenteeism rate for MR, VR and Marketing is 0.0064, 0.0029 and 0.0114, respectively. It is calculated by dividing absent man-days due to loss of pay by total hours worked. The occupation disease rate is reported as nil
- Lost time Injury Rate includes fatalities + lost workday cases
- Total No. of recordable injury incident rate includes fatalities + lost workday cases + restricted workday cases + medical treatment cases

People Performance

HSE Highlights

Mumbai Refinery

- Achieved highest ever 27.52 Million man-hours of safe operation and completed 59.02 Million safe man-hours of contract workers
- Safely handled FR short shutdown for project work. Took up FR APS rerouting of 26 process lines for Mumbai Refinery Expansion Project (MREP)
- Enhanced awareness on safety through videos, safety plays and books

Visakh Refinery

- Completed accident-free revamping T&I of MS Block and DHT block
- Enhanced awareness on safety through animation videos on firefighting equipment, PPE and rescue equipment. Also deployed a dedicated Safety training vehicle for onsite training
- Launched online tool for Senior Management safety tour (T Suraksha)
- Developed and rolled out online fire and safety inventory management system
- Developed VRMP-project monitoring centre for smart and effective monitoring of various project sites

HSE - Corporate

- Conducted safety inspections at project sites at Mumbai and Visakh refineries, fire safety and electrical safety audits at our headquarters and information systems centre, Hyderabad, pre-commissioning safety audit of LPG pipeline to URAN
- Coordinated and conducted multiple training programmes throughout the year on topics covering basics of safety, fire safety and emergency preparedness, electrical safety, cathodic protection for MSVs and cross-country pipelines, crane safety, HSE legal framework on health and safety, Dupont Stop Behavioural safety and process safety management
- Carried out accident investigations and incident analysis
- Coordinated with Marketing SBUs and refineries for compiling and submitting dashboard data with respect to safety and environment parameters as per requirements of MoP&NG
- Participated in technical review of OISD Standard 112 (safe handling of air-hydrocarbon mixtures and pyrophoric substances)



71

Training Program on Road Safety for TT Crew 'Sadak Suraksha se Jeevan Raksha'



7

Mock Drill in progress for emergency preparedness

- Released various publications such as ten-year refinery incident analysis, crisis management plan, lifesaving rules, environment legislation reckoner on Environment Acts and Rules, among others
- Developed and circulated online technical bulletins and newsletter on various topics related to HSE and sustainability

HSE - Marketing

- Conducted several surveillance safety audit of marketing locations, retail outlets, electrical safety audits, construction sites, LPG private bottlers and LPG distributor premises. Also, coordinated with SBUs for compliance with audit recommendations
- Organised inhouse training programmes for extended workforce (TT crew, contract workers, retail outlet staff and so on) to enhance knowledge on SOPs and safety during transportation covering over 6,200 participants
- Set up trainings through external faculties to enhance knowledge on field officers about applicable Acts, rules, consents covering over 300 field officers
- Carried out various innovative activities with respect to SOP adherence, audits, TT crew welfare facilities, e-tools for inspections, training modules for TT crew, among others
- Coordinated for observance of important HSE related events, such as fire service week, World

Environment Day, National Road Safety Week, National Safety Week across locations

- Carried out allied supporting activities, such as sharing learnings and common observations from audits with SBUs, deliberations at industry meetings, release of bulletins for awareness, training sessions for officers and students, among others

LPG SBU

- Organised Oil Industry Safety Directorate (OISD) workshop for Safety Officers, Plant Managers and Zonal HSE members
- Conducted live fire trainings at IFSDMS, Vadodara covering 117 personnel
- Organised training programmes by NITIE (Mumbai), at HPMDI for Safety Officers and Plant Managers on Risk Assessment and Emergency Preparedness
- Conducted bomb threat drills, onsite fire drills and offsite DCMP fire drills at various plants
- Conducted training programme for Project Officers on structural design and variable frequency drives for electrical motors
- Developed test cylinder at Visakh LPG plant to check the functionality of interlock for non-lifting of sealing bell of online valve changing unit in case there is pressure within. The system enhances safety during SC valve changing operation

People Performance

- Developed remote monitoring of CP system of MSV at Panagarh LPG plant. The system enables real-time PSP reading monitoring of reference cells of the CP System with real-time monitoring of health of the anode

O&D SBU

- Rolled out revamped HSE index across locations
- Achieved reduction in road accident through effective monitoring of speed violations during trips through VTS
- Driver risk assessment and improvement programme were implemented at Bhatinda IRD. The programme involves real-time, on-road assessment of driver behaviour to enable improvement in their driving risk through personalised interventions
- Felicitated the best transporter and the best dealer-cum-transporter at the 5th edition of All India Category - S Transporter Meet, which is a formal framework developed by O & D to recognise better performing and safe transporters
- Conducted Live Fire Simulation programs covering over 1,190 personnel at IFSDMS, Vadodara
- 9,173 drivers were certified under Recognition of Prior Learning (RPL) - IV. First SBU among the OMCs to achieve the committed target
- Vashi Terminal organised Behaviour Based Safety workshop through M/s DNV wherein 61 participants

of different groups i.e. Company non-management staff, TT crew, Security and contract workers participated

PROJECTS & PIPELINES SBU

- Commissioned pipeline intrusion detection system (PIDS) in 1,879 km covering over 3,500 km of pipeline network
- Introduced SACHET-behavioural based safety initiative in pipelines
- Organised a unique alignment meet of internal stakeholders and security agencies - 'Ekagra' - an ecosystem based development intervention launched with the objective of strengthening the security and safety of the pipelines

HPGRDC

- Achieved 1,372 cumulative safe research days
- Completed External Safety Audit (ESA) by M/s DuPont sustainable solutions
- Implemented Lock Out Tag Out (LOTO) system for improvement in electrical safety
- Trained 20 R&D Officers for site emergency response at IPSHEM-GOA
- Formed Institutional Biosafety Committee (IBSC)
- Conducted mock drills and added various HSE related Infrastructure
- Designed safety orientation videos for visitors



71
Live Fire Simulation Trainings to operating personnel

HALE AND HEARTY HPCL

In keeping with the adage, 'A healthy mind resides in a healthy body,' we take utmost care to secure the health and well-being of our workforce. We have proactively undertaken myriad initiatives to continuously enhance the productivity of our people.



Our employees and their dependents are covered under a comprehensive health insurance policy. We have also facilitated a health insurance policy for dependents of employees not covered in the Corporate health insurance policy. An online wellness portal provides latest articles, news and other information on topics of health and well-being.

Our workforce undergoes periodic medical examination to root out any developing ailments. Designated physicians are provided at major marketing locations, while smaller locations have tie-ups with local hospitals to ensure accessibility to health services. We also have empanelled hospitals to provide superior medical care to our employees and their dependants.

Contract workers and TT crew working at our locations are facilitated with health camps and are guided on health issues. In these check-ups, workers are made aware of their current health status and are advised suitable measures to maintain normal health and avoid illness.

During the year, a number of workshops and health camps were organised across locations for employees and their families, towards fulfilment of the objective of 'Hale and Hearty HPCL'.

People Performance

#HumFitTohHPFit Challenge 2019

The #HumFitTohHPFit Challenge 2019 was organised for the second year in a row after its stupendous success in 2018. The event again received a tremendous response with a record 8,885 entries from HP Pariwar members across Corporate, Marketing, Refineries and Zones. HPites broke their own 2018 record of clocking 2,03,54,49,557 steps cumulatively (equivalent to 14,03,758 km) by collectively walking 2,12,22,79,289 steps (equivalent to 14,63,641 km) in 2019.

Biggest Loser Challenge

A unique 60-day health initiative called Biggest Loser Challenge was organised for the Kolkata-based employees and family members wherein employees who were the biggest loser in terms of percentage weight were declared winners. To motivate employees, various catalyst events were organised for the participants.

Health talk/check-up camps

Various zones conducted Health Talks and Check-up camps on a variety of themes to ensure wholesome health and well-being of employees and other stakeholders. During the year, over 48 Health Talks were conducted at various locations on subjects like diabetes, breast cancer, kidney ailments, cholesterol,

diet and lifestyle, bone density test and diabetic neuropathy, eye check-up, health check-up and so on.

Paramarsh

Counselling plays an important part in the mental well-being of individuals. We have an Employee Assistance Programme (EAP) called 'PARAMARSH', available in multiple languages to provide our employees, their spouses and children consultation on personal or professional matters. This consultation is provided by independent expert counsellors, who maintain a high level of confidentiality. It is a 24x7 service that can be accessed over the telephone, on the mobile app and through live chat and email.

ESIC Anniversary Celebrations

South Central Zone-LPG organised awareness-cum-health check-up camps at Visakh LPG terminal during the 68th fortnight of ESIC Anniversary Celebrations in association with AP Factories Department covering ~500 contract workers from various organisations around Visakhapatnam.

International Yoga Day

HPCL locations and housing colonies observed International Yoga Day to reinforce the importance of practicing Yoga for physical and mental well-being among HPites.



↗ An awareness-cum-health check-up camp at Visakh LPG Terminal

Happiness Initiatives

Our Mumbai Refinery conducted corporation wide Happiness Survey of employees during the year. Various activities clubbed under HapPyCL initiative like creation of Happiness Zones, posters, stickers, WhatsApp challenges and so on were carried out to enhance the overall happiness index.

Promotion of Sports

HPCL plays a significant role in promotion of sports and regularly participates in various tournaments organised under the aegis of Petroleum Sports Promotion Board (PSPB) and All India Public Sector Sports Promotion Board (AIPSSPB).

During 2019-20, HPCL organised Annual Sports Meet, sports and games tournament and cricket tournament for its employees on all-India basis and introduced additional games like carrom and chess exclusively for employees covered under Persons with Disabilities Act 2016. In addition, HPCL hosted various tournaments for Petroleum Sports Promotion Board (PSPB) and All India Public Sector Sports Promotion Board (AIPSSPB) during the year.

The Hon'ble President of India conferred Shri Arup Basak, an employee of HPCL, with Dhyaanchand Award for his outstanding achievements and contributions to the game of table tennis.

Tackling the COVID-19 Crisis

In the wake of the outbreak of the pandemic worldwide, our various locations conducted numerous programmes to raise awareness on general precautions, mandatory guidelines, treatment and myths around the prevention and spread of COVID-19 apart from streamlining workforce allocation and work-from-home arrangements to ensure uninterrupted business operations.

Some of the initiatives undertaken are:

- Staggered and balanced availability of workforce to ensure continuity of operation and safety
- Carrying out awareness sessions on COVID-19
- Circulation of Do's and Don'ts on prevention of the infection
- Distribution of medical PPEs to medical staff members
- Thermal screening and provision of masks, hand gloves, sanitisation facilities and maintaining cleanliness at our premises
- In-house preparation of cost-effective sanitiser to ensure continuous availability
- Constructive engagement with employees and their family members for awareness and confidence building
- Online yoga and meditation sessions for employee well-being

ASSET SECURITY

Reliable assets are an important contributing factor in the continuity of our operations. We deploy best-in-class technology, trainings on maintenance of equipment and reliability improvement measures to meet our objectives of a safer and secure working environment and maintaining asset security.

Our M&I teams inspect our facilities and carry out timely maintenance of assets. They also assess potential risks, prepare mitigation plans and identify the need for new investments towards improving asset integrity with the aim of achieving safe, incident free and efficient operations.

DELIGHTING THE CUSTOMER

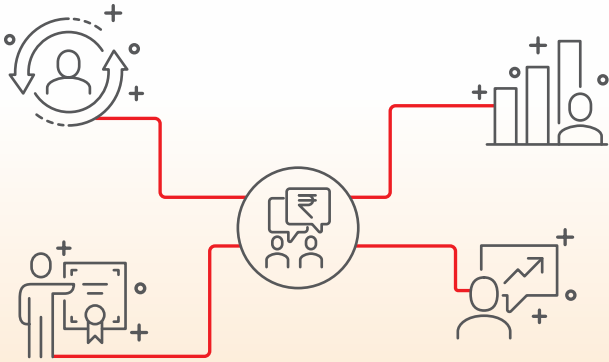

- 105 Research & Development
- 108 Quality Assurance
- 109 Quality Control
- 110 Customer Focus





Delighting the Customer

DRIVING CUSTOMER CENTRICITY

We believe in 'Delivering Happiness' to our customers with quality products and innovative services across markets. We are responding to the changing needs of customers by undertaking many customer-centric initiatives and effectively managing Health, Safety and Environmental (HSE) risks across the value chain.

We focus on developing products that have high performance efficiency and are safe with minimal environmental impacts. Health, Safety and Environment (HSE) parameters are of utmost importance throughout the lifecycle of the product and we recognise the HSE impact not only at the manufacturing stage but also across the various stages of the supply chain. Several endeavours to manage and minimise the health, safety and environmental risks and impacts of our products are undertaken.

We accord priority to safety, health and environment, right from the manufacturing locations and transportation to end users. We recommend proper storage and handling procedure of lubricants to consumers so that products are used in a safe manner for intended application with greater output to avoid wastage of products. We communicate potential risks and specify proper product management practices to consumers and the public. We have a well-defined mechanism to communicate information pertaining to customer safety through website, booklets newsletters, specification, Material Safety Data Sheets (MSDS).

Relevant information as per applicable national and international laws is displayed on our product labels. Our products are in line with BIS specifications, internationally accepted and customer specific standards. All lubricant packages/labels must comply with Legal Metrology (Package Commodities) Rules, 2011. As per the rules, Lube packages label should contain declaration of Quantity, MRP, Manufacturing Date, Manufacturer Name and Address, Customer Contact Details, Generic Name of product and so on. We have not recognised any non-compliance pertaining to applicable legal requirements of product labelling regulatory codes.

There was no non-compliance related to unfair trade practices or irresponsible advertising as per applicable regulatory codes in the reporting year. However, there are six pending cases related to alleged anti-competitive behaviour, as on March 31, 2020. We do not market any product that is banned or disputed.



71

Launch of branded MTO 'HP Shine' in barrels

RESEARCH & DEVELOPMENT (R&D)

R&D is a crucial component of innovation and a key factor in developing new competitive advantages. To further catalyse and provide impetus to our research capabilities, we have set up a state-of-the-art facility, the Hindustan Petroleum Green Research & Development Centre (HPGRDC) at Bengaluru. The facility is a 'Platinum' rated building by IGBC and 5-star-rated by GRIHA Council in a sprawling campus spanning 120 acres.

HPGRDC has been set up with an objective to provide advanced technological support to marketing SBUs and refineries, develop and adopt path-breaking technologies and become a knowledge hub. Continued focus on enhancing R&D capabilities for the development of new products, processes and technologies in the energy sector enabled us to reach several significant milestones. We have filed 16 patents during the year, taking the cumulative Indian and International Patent Cooperative Treaty (PCT) applications to 139. In the reporting year, 30 patents were granted, including 20 national and 10 international, taking the total patents granted to 46.

Green R&D Centre Highlights

Technologies demonstrated

- [HP]²FCC catalyst at VR in FCCU-II
- HP-TSA (Temperature Swing Adsorption) technology in air pre-purification unit of the cryogenic nitrogen plant at VR
- SprayMax FCC Feed Nozzles in VR FCCU-II

Products Developed/Launched

- HP-BIOREMEDIA: A novel microbial formulation for remediation of crude oil sludge, with trials carried out successfully at Visakh Refinery
- HP THERMOPRO: A chemical formulation to reduce the fouling in heat exchangers. Trials successfully completed in CDU-I and CDU-III of Visakh Refinery
- HP SEU Neutmax: A novel neutralising amine for Solvent Extraction Unit (SEU) at Mumbai Lubes Refinery to replace the import chemical. Field trials are in progress
- HP DWA: An improved version of dewaxing aid for propane dewaxing unit (PDU) at Mumbai Refinery to replace the import chemicals. Field trials successfully completed for 150 N grade
- HP DEWA: A dewatering and sludge inhibitor additive for crude storage tanks. Test carried out at lab scale, scale up completed and the chemical sent to Visakh Refinery
- HP i²Face: An inert interface material to replace SKO plug in multi-product pipeline. Scale up is in progress
- HP-SAN: A novel hand sanitiser

Products handed over for Commercialisation

- HP-DUCER, HP-NEUTMAX, HP-BIOACTIVA, HP-THERMOPRO, HP-IPCA, HP-CoSoL

Technologies under Development

- HP-DAK: Detailed engineering and execution of the plant at Mumbai Refinery has been started
- HP-COAT: Technology Design Document (TDD) completed. BEDP to set up a demo plant at Visakh Refinery is under development
- PSA PLC System: In-house PLC sequencing and programming module has been developed and tested at pilot level. Demonstration of the technology will be carried out at Visakh Refinery
- Hydrotreating Catalyst Technology: Hydro-treating catalyst for BS-VI diesel was developed at pilot scale, achieving less than 8 ppm of sulphur. The catalyst is being scaled up for use at our refineries
- CCR Catalyst: Naphtha reforming catalyst has been developed and tested at pilot level. Scale-up studies are in progress
- HP-SHC Technology: Residue Slurry Hydrocracking Technology has been developed and tested at pilot scale
- Kero Hydrotreater: Catalyst and reactor internals design completed. BEDP to convert HGU-PDS for kero hydrotreating is being prepared in-house
- Commissioning of Slurry Oil Filtration System at VR FCC-1 done, as a part of Viscat technology demonstration

Strategic Tie-ups

Our R&D Centre has been collaborating with reputed institutes. Some are as follows:

- Carried out professional testing services to Commonwealth Scientific and Industrial Research Organisation (CSIRO), Australia for Metal Organic Framework (MOF) material for CO₂ adsorption
- Signed MoU with the Central Institute of Plastic and Engineering Technology (CIPET) for technical services for Petrochemical lab
- Joined as Industry Member in CISTAR research programme coordinated by Purdue University, USA

Delighting the Customer

Laboratory Information Management System

As a part of digitisation, several online applications, such as online alert management system, literature indexing portal, process simulation software, among others, were deployed to enhance efficiency and automation. A unique ‘Laboratory Information Management System (LIMS)’ has been implemented, which includes E-Log, Design of Experiment, Chemical Inventory Management, among others. With the implementation of LIMS, all laboratories at our R&D Centre will have structured and streamlined laboratory processes of tests, experiments, information management and related administration processes. It will also reduce cycle time and boost the speed of research projects, while providing a high level of information security to all research data. LIMS has been implemented along with Electronic Lab Notebook (ELN) module, to move towards paperless laboratories and enhanced information security.

Lube R&D Highlights

Automotive Sector:

Implementation of BS-VI norms for emission in the automotive sector will witness many fold changes in fuel injection technology and exhaust equipment in both diesel engine and passenger car segment. This has necessitated the development of high performance long drain energy efficient engine oil which should be compatible with after treatment device. High performance lubricating oils, leading to durability of the after treatment devices, improved fuel economy and improved energy efficiency are the need of the market with reduced Green House Gas (GHG) emissions. Synthetic engine oils, motor cycle oils and gear oils help in achieving extended drain intervals due to longer thermal and oxidative stability, leading to lower oil consumption and hence reduced disposal of environmentally polluting waste oil and certain suspended contaminants which may be toxic and hazardous to the environment. Additionally, through increased use of renewable raw materials/additives, reduction in oil consumption, less disposal issues and conservation of energy resources can be achieved. Our role is also to take care of manufactured material by recommending effective solution to corrosion management and storage of products so that they are long-lasting.

HPCL lubricants pioneer a category of long drain engine oils, hydraulic fluids, greases and other formulations that help to deliver maximum protection of equipment, extend their life and reduce oil consumption.

A range of HPCL’s lubricants for farm tractors and off highway equipment meets biodegradability and non-toxicity in application where leakage or spillage of conventional oils could result in damage to human life and environment.

Industrial Sector:

Hydraulic oils for excavation and the mining sector in India:

To meet the increased requirements of higher efficiency and better functionality of hydraulic systems, new components and system concepts have been developed over the years. However, the most important component in a hydraulic system, which

has a major impact on system efficiency and wear is the fluid itself. In the last decade, major attention on hydraulic fluid development has been set upon environmental adaption.

HPCL has developed high quality high performance hydraulic oils which are energy efficient, leading to upto 5% improvement in fuel consumption.

Compressor Oils

HPCL has developed high quality high performance fully synthetic compressor oils for very high capacity compressors for air, LPG and other gas applications. These oils have very long life and are eco-friendly. Due to inherent biodegradability, they help in preventing land and water pollution.

Metal Processing and Protecting Oils/Lubricants

Various initiatives were taken for the development of metal processing and protecting oils and lubricants for various customers like steel plants, metal processing, tyre manufacturers and vehicle accessories



manufacturers by analysing, evaluating, developing and recommending most effective and viable solution on corrosion management. Various metal protective oils were developed to reduce overall oil consumption at the customer end, hence reducing environmental impact. HPCL developed various cutting oils, drawing oils and quenching oils to achieve cost effectiveness, longer life, energy efficiency and protection of environment.

Lubricating Greases

Explored the development of high performance long life greases for the cement sector, which will increase the life of machines, give higher production, require less replacements and will protect the environment.

Expenditure incurred on Research and Development

(₹ Crore)

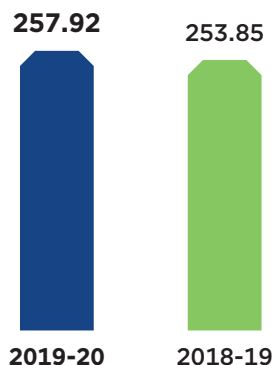

Various synthetic lubricants were developed to deliver improved fuel economy and longer drain intervals during the year:

GRADE NAME	VISCOMETRICS	APPLICATION	PERFORMANCE LEVEL	SEGMENT
HP NEOSYNTH ECO 6	5W 30/0W 20	PETROL/ DIESEL	API SN PLUS, ACEA C2	PCMO
HP RACER SPLENDID	10W 30/20W 40/20W 50	PETROL	API SJ, JASO MA 2	MCO
HP RACER ECO 6	10W 30/20W 40	PETROL	API SN, JASO MA 2	MCO
HP RACERSYNTH PRO	10W 50	PETROL	API SN, JASO MA 2	MCO
HP MILCY TURBO ECO 6	15W 40	DIESEL	API CK-4, ACEA E9, VDS 4.5, MB 228.31, CES 20086	3 W
HP MILCY TURBO ECO 6	15W 40/10W 30	DIESEL	API CK-4, ACEA E9, VDS 4.5, MB 228.31, CES 20086	HDDEO
HP MILCY TURBO ULTRA	15W 40/10W 30	DIESEL	API CJ-4, ACEA E9, VDS-4, MB 228.31, CES 20081	HDDEO
HP MILCY TURBO ULTRA +	10W 40	DIESEL	API CK-4, ACEA E 6/E7/E9, VDS 4, MB 228.51, CAT ECF-3, CES 20081	HDDEO



Delighting the Customer

QUALITY ASSURANCE

We are focused on delivering the best quality products to our customers. We believe quality is not merely meeting standards, but it is the value being delivered to the customer. We have stringent quality checks in place at each step of our supply chain. Providing quality assurance is an integral part of our systems and processes and we continue to deliver as per our stakeholders’ expectations.

In line with the directive of the Ministry of Petroleum & Natural Gas (MoP&NG), HPCL has a dedicated Quality Assurance (QA) cell with officers posted across zones and its functioning is independent of the Refining and Marketing functions. QA cell carries out surprise inspections covering retail outlets, Kerosene (PDS) distributorships, LPG distributorships, supply locations in compliance with the revised Marketing Discipline Guidelines (MDG) and HQO directives.

During 2019-20, the QA cell carried out inspections at 3,431 retail outlets, 47 Kerosene (PDS) distributorships, 531 LPG distributorships and 41 LPG bottling plants. Establishment of a robust QA system enabled HPCL to set high customer service benchmarks for supply locations and channel partners and provide high quality products and services to customers.

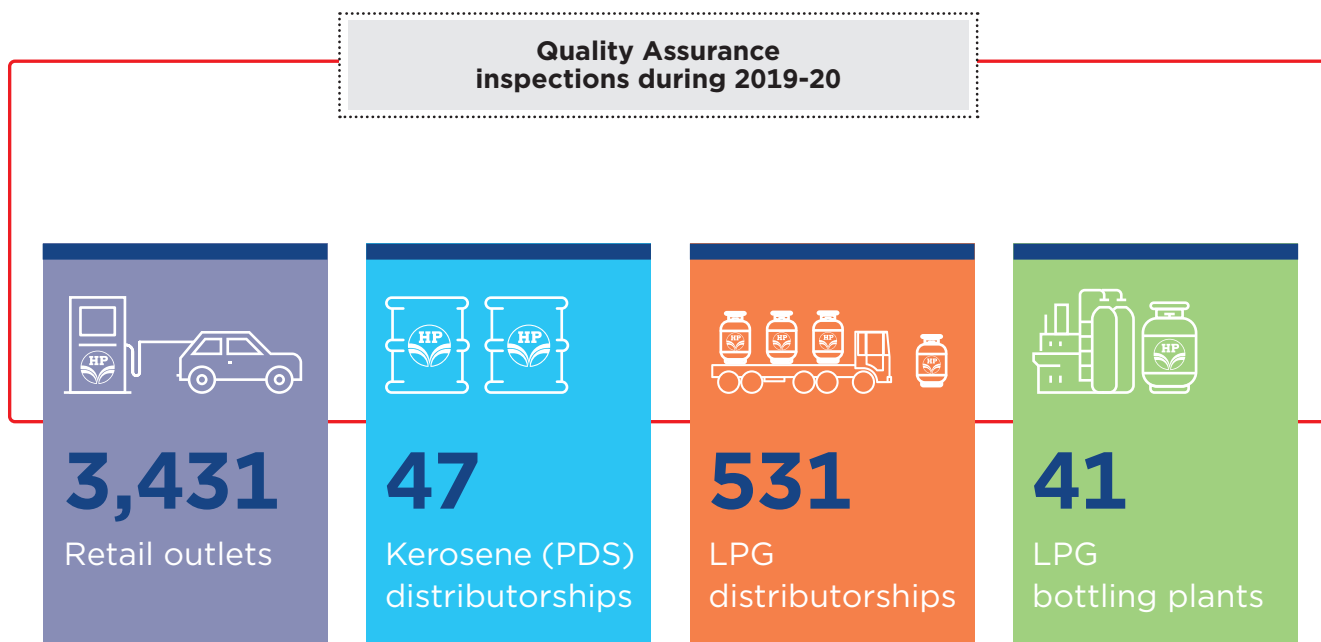

Establishment of a robust QA system enabled HPCL to set high customer service benchmarks for supply locations and channel partners and provide high quality products and services to customers

QUALITY CONTROL

Our unwavering commitment to delivering quality products to our customers is a reflection of our organisation's values and promise of 'Delivering Happiness' to customers. We have stringent quality management systems for our varied range of businesses and products. We adhere to Industry Quality Control Manual (IQCM) of the oil industry to manage the product quality at various stages.

We maintain quality with the help of our extensive pan-India network of laboratories designed as per the requirement of the Oil Industry Safety Directorate (OISD). HPCL has established a network of laboratories across the country. These labs are equipped with state-of-the-art equipment, well-trained workforce and certifications or accreditations in the field of testing.

Our products are tested with precision in our laboratories as per applicable standards. Our labs are regularly audited internally and inspected by external agencies as well. Our QC department circulates QC bulletins to employees for awareness creation.

Launch of Bharatiya Nirdeshak Dravya

HPCL in collaboration with the Council Of Scientific And Industrial Research - National Physical Laboratory – also known as National Measurement Institute of India (CSIR-NPL) has developed and released 28 Certified Reference Materials (CRMs) named as petroleum Bharatiya Nirdeshak Dravya (BNDs) or Indian Reference Materials. These BNDs ensure traceability to SI systems in the testing and certification of vital parameters of petroleum products. They ensure the highest quality standard in petroleum products and in foreign exchange savings. These BNDs were launched on Code d'Indexation des Matériaux de Référence (COMAR), an international agency based in Germany, which assists users in finding the Certified Reference Materials they need, thereby giving global reach for the BNDs (CRMs) developed by HPCL.

Vashi QC Lab Proficiency Test

National Accreditation Board for Testing and Calibration Laboratories (NABL) has accredited HPCL Vashi lab facility as a Proficiency Testing (PT) provider for simultaneous PT scheme in the field of petroleum testing (Chemical). The accreditation has been granted after a three-layer audit by NABL assessors in accordance with ISO/IEC 17043:2010 and acceptance by the apex accreditation committee. Proficiency testing determines the performance of individual laboratories for specific tests or measurements and is used to evaluate laboratories' continuing performance against the pre-established criteria by means of inter-laboratory comparisons. HPCL bags this accreditation with the widest scope covering 66 parameters in fuels and 52 parameters in the lubricants. The scope covers the entire range of petroleum products, including MS, HSD, HFHSD, SKO, ATF, Bio-Diesel, FO, LDO, Hexane, Solvents, Engine Oil, Gear Oil, Hydraulic Oil and Transformer Oil with full specification test.



Delighting the Customer

CUSTOMER FOCUS

We aspire to be a world-class energy company known for caring and delighting the customers. We continuously strive to improve our services by exceeding our customers' expectations and offering them best-in-class products and services. Our approach has always been of 'Delivering Happiness' to our customers.



Awareness on LPG Safety through PM LPG Panchayat

We provide enjoyable experiences to our customers by way of communication mechanism, network outreach, understanding their requirements and expectations and shortening the cycle time.

Our customers are instrumental in improving our product delivery by providing valuable feedback. We have several communication channels through which we engage with them. The feedback helps in understanding the interventions required to enhance the efficacy of the system.

Over the years, we have expanded our network in multiple folds. We commissioned 1,194 Retail outlets in the reporting year, taking the total to 16,476. The vast network helps us in offering customer convenience across geographies. Achieved complete automation of operating/active retail outlets, attaining new industry benchmark of 94.8% of 'No Automation No Operation' (NANO) at the automated outlets.

In the LPG business, during the year 2019-20, we served over eight crore customers with the HP GAS network of 6,110 distributors.

HPCL has been significantly participating in the Pradhan Mantri Ujjwala Yojana (PMUY) and working to take the benefits of user-friendly clean fuel to the markets at the bottom of the pyramid. During the year, 19.56 Lakh connections were added under PMUY. As of March 31, 2020, HPCL enrolled 2.15 Crore beneficiaries under the scheme. The year saw us conduct 10,824 PM LPG Panchayats and numerous safety clinics to educate customers about the safe handling of LPG.

Customer Experience Enhancement Initiatives Going Digital

Digitalisation is helping businesses transform with a single purpose of creating greater value - using technology that helps generate new ways of thinking. Businesses can use digitalisation to expand into new markets, achieve operational excellence, enhance communication and delight customers. We at HPCL, leverage digitalisation to deliver value to our customers.

Customer-Centric Digital Initiatives 2019-20

- Launched 'HP Pay', a unified customer facing mobile app for HPCL customers
- 'HP Pay' is a wallet based closed-loop payment solution that can be used for the purchase of motor fuels, domestic LPG and lubricating oils for vehicles. It is a unique industry first one-stop solution for customers for their fuel needs
- Introduced the integrated payment solution, with a concept of 'What is filled is billed'. This entails the integration of dispensing units and various payment solutions under a single device. The concept and workflows were devised in-house with a unique OCR technology feature, which can also read vehicle number
- First OMC to go live on Bharat Bill Pay system for domestic cylinder refill booking and online payment services
- Launched WhatsApp services for LPG consumers for refill booking, subsidy details, quota details and other services

Launch of Retail Automation Manual

HPCL was the first organisation among OMCs in India to recognise the potential of the emerging technologies and begin retail automation in the year 2003. Since then, we have come a long way, with our entire network of operative retail outlets being equipped with retail automation.

Retail automation has strengthened the brand image of HPCL, which is based on positive quality and quantity perception, customer care and vehicle care. The system benefits stakeholders viz. the dealers, the Company and end-customers. It provides transparency and control on the facets of retail outlet operations and performance.

An Automation Manual was launched covering detailed operations and features of retail automation at HPCL. The manual describes various components of retail automation and their uses. It develops user-level understanding of various features of retail automation. It contains pictorial depiction of the whole system for better understanding of the user. It also gives details of various transaction and performance reports.

Customer Safety

As an integral part of the business, we believe that no work or service or activity is so important or urgent that safety be overlooked or compromised. We have stringent systems in place to ensure utmost safety. Customer awareness has been the foundation of our approach towards customer safety. We have been striving to achieve and maintain high standards of safety in our operations. During 2019-20, there was no incident involving non-compliance of regulations and voluntary codes concerning health and safety impacts of products.

Loyalty Programmes

HPCL offers payment solutions at retail outlets for the convenience of its customers. We have specifically designed segment specific loyalty programme to cater to various categories of our customers. We have been introducing, modifying and launching various schemes on loyalty and rewards programmes from time to time. Some of these are:

▪ HP Pay

HP PAY is a powerful loyalty and payment programme that provides complete fuel management solution to its owners and operators in the form of an unbeatable combination of control, convenience, security and attractive reward points.

▪ Drive Track Plus Programme

DriveTrack is another loyalty programme offered by HPCL. It provides reward points, convenience, special

offers to customers and a complete fleet management solution. It provides better control over transaction with easy recharge facilities. This card can be used at our participating petrol pumps for the purchase of fuels and lubricants on a pan-India basis.

We provide other co-branded credit and debit cards with attractive benefits. We also have attractive reward scheme under PAYBACK card programme.

▪ Customer Feedback

We engage with our customers both directly and indirectly through various channels of communications and interactions to understand their expectations and perceive opportunities for delivery improvement, which we resolve through timely interventions.

Customer Surveys 2019-20

Retail

HPCL retail strategic business unit has leveraged the Customer Relationship Management (CRM) information technology and analytics-based Customer Feedback Score metric to monitor satisfaction levels among the motorists fueling at HPCL retail outlets. The feedback score given by the individual customers in the CRM system are reflective of the high consumer satisfaction levels. A similar consumer satisfaction level among HPCL customers also emerges from the Government of India Centralised Public Grievance Redress and Monitoring System (CPGRAMS) portal, and the government has been appreciative of HPCL in this regard.

LPG

LPG SBU has developed HP GAS domestic customer feedback application, which can be used by customers to provide feedback. Upon receipt of refill delivery, an SMS with a link to provide feedback in the application is sent to the customers. The customer is prompted to provide feedback on various services offered by distributors and provide overall satisfaction rating on the performance of distributor. During 2019-20, a total of 13,229 customers rated services of HP Gas distributors at level 4* or 5* (5* Excellent category). Apart from this, LPG SBU received feedback from 13,941 customers through CRM portal. These comments were noted and used for improvement in services. Basis customer feedback, LPG SBU enabled multiple options for refill booking apart from IVRS, missed call, online booking and cashless payment through various app based applications like HP Pay, BBPS, UMANG, BHIM, e-wallets (Paytm, GPay), credit or debit card, among others. The SBU enabled digital payment options at customers' doorstep through HP Vitaran app, available with the LPG delivery staff. The SBU is in the process of development of geo coordinate based delivery route optimisation for gas delivery staff, which will enhance delivery efficiency.

In this reporting period, the Company has received a total of 2,68,268 complaints, out of which 2,64,203 (98.48%) have been resolved and remaining 4,065 (1.52%) cases shall be addressed within timelines.

CORPORATE SOCIAL RESPONSIBILITY

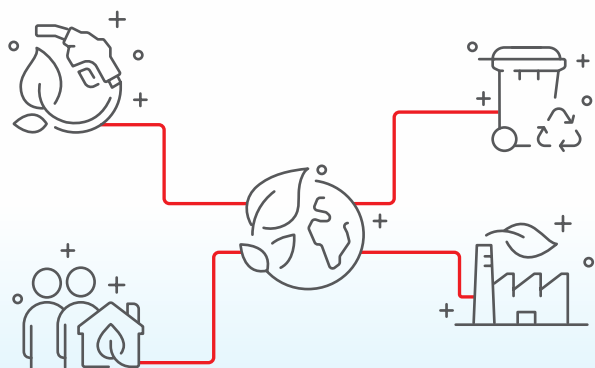

- 114 CSR Approach
- 115 Focus Areas
- 116 CSR Footprint





Corporate Social Responsibility

OUR ROLE IN SOCIETAL PROGRESS

We have been practicing the CSR model of 'Creating Shared Values' by reaching out to the stakeholders, including society at large who are directly or indirectly involved with our business. We have been striving to build a better and sustainable way of life for the marginalised and less-privileged sections of the society. This helps strengthen local communities, which, in turn, fosters social stability and intensifies our relationship with stakeholders. We understand that business and society are dependent on each other, thus we always believe in inclusive growth by 'Delivering Happiness' and making positive impact in the lives of people through proactive and participative engagement.

CSR APPROACH

Our CSR approach focuses on sustainable development by delivering economic, social and environmental benefits to the society.

We have a Board-approved CSR policy, which defines the scope, structure and guidelines for identification, implementation and monitoring of CSR projects and initiatives. The policy aims to address the developmental challenges faced by the communities.

We have a Board level sub-committee - CSR and Sustainability Development (CSR&SD) Committee, comprising Whole-time Directors and Independent Directors, who oversee and execute Board-approved CSR plans, provide inputs to strengthen the strategy, ensure effective needs assessment and review project progress.

Additionally, we have various committees in place to design and implement CSR projects:

CSR Council

The role/responsibilities of the CSR Council include:

- Suggest CSR activities to the CSR Department which align with the Corporate Vision
- Review quarterly the CSR activities and expenditure vs budgets, for midcourse corrections, if any

CSR Management Committee

The role/responsibilities of the CSR Management Committee include:

- Review the proposals for CSR projects, programmes or activities received from various locations
- Approve proposals of value between ₹40 Lakh and ₹70 Lakh against approved allocated budget

CSR Working Committee

The role/responsibilities of the CSR Working Committee include:

- Review the proposals for CSR projects, programmes or activities received from various locations
- Approve proposals of value less than ₹40 Lakh against approved allocated budget

FOCUS AREAS

Our CSR focus areas are inspired by our vision and mission statements. These are aligned with international developmental goals and national policies and legislations on Child Rights, Child Development and Education, National Health Policy and National Health Mission, Health Care in India-Vision 2020, National Skill Development Mission, and policies on community or rural development.

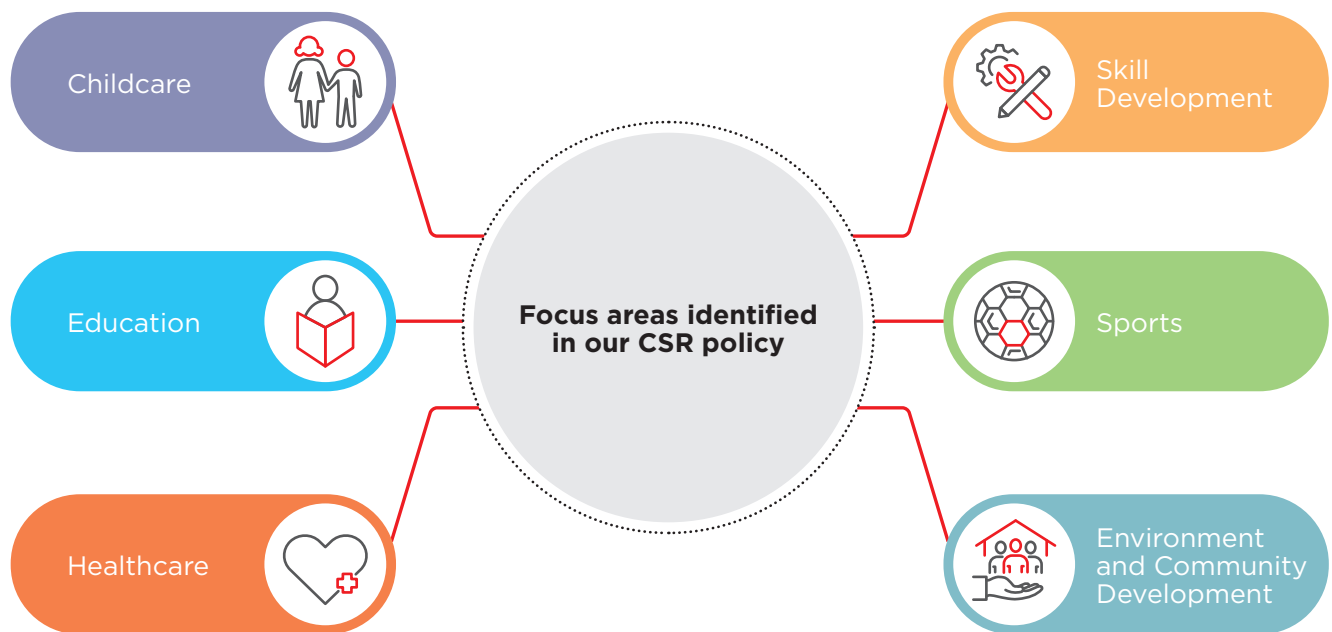

Monitoring and Evaluation

We have always believed in being a catalyst of transformation through our CSR endeavours. We are committed to delivering happiness by making meaningful changes in the lives of people through our community engagement and holistic social development. Being a responsible corporate citizen, our constant effort is to maximise the positive impact of our initiatives by integrating and internalising CSR into the core of business operations.

We give utmost importance to monitoring and measurement in our CSR projects. Periodic evaluation helps us make better decisions to improve the

efficiency of the programmes. It guides our intervention required to meet the objective of the project.

We have a very robust system to allocate and utilise the CSR budget. The monitoring process happens through a two-tier mechanism:

1. CSR Committee on quarterly basis
2. CSR Council on quarterly basis

In addition to the above, third party impact assessment of major projects is also carried out.

Corporate Social Responsibility

CSR FOOTPRINT

We carried out various interventions during the year to create positive impact on the society. We have been able to touch the lives of thousands of beneficiaries through our initiatives.

With our targeted approach and committed workforce, we have executed multiple meaningful projects across the country under various CSR focus areas in collaboration with the local administration / community.

CSR Interventions 2019-20



Childcare & Education

We understand that focusing on these two areas is paramount to a long-term impact on the beneficiaries. We plan to build a stronger foundation in education through specialised training, skill development and providing nutritious meal to students. We also implement projects related to women empowerment and education of differently-abled individuals, resulting in sustainability becoming a cornerstone of our initiatives and programmes.

Noteworthy Activities

Project ADAPT

Disability is probably one of the least understood and accepted conditions in the society. Guiding ourselves to see the ability beyond the disability and ensure equal opportunities and dignity to Persons with Disability requires effort, awareness and mobilisation beyond just addressing their medical needs. It is in the spirit of this endeavour that we are supporting inclusive education, therapeutic needs and vocational training of children with disabilities.

The key objectives of the programme are to provide quality school education, and therapeutic support to every disabled child enrolled in the school and provide an enabling environment so that they may realise their full potential.

We supported the holistic development of 300 special children by providing education, therapies and vocational training through this project during 2019-20.

Project Akshayapatra

Hunger and malnutrition are considered one of the the foremost factors hampering education. In realisation of this fact we rolled out the mid-day meal programme. We are bridging the gap by providing hygienic and nutritious food to students from rural areas of Visakhapatnam and Vijayawada through

specialised agencies. This programme has addressed a vital requirement of young children from the rural areas belonging to economically marginalised sections. The intervention through this programme has resulted in higher enrolments and negligible dropouts from schools.

The key objectives of the programme include avoiding classroom hunger, increasing school enrolment and attendance, improving socialisation and addressing malnutrition.

We supported the nutritious mid-day meals of 20,000 students through this project during 2019-20.



20,000
Students supported through Akshayapatra project

Project Nanhi Kali

Encouraging girl child education and building gender equality among communities remain a pertinent social challenge. Our intervention in this project includes providing material support to first generation girl child learners from tribal and migrant communities. The major component of the project is to provide academic and social support to the girl child to continue education and meet challenges of the modern educational setup. Through this planned intervention, we have been able to reduce girl dropouts, helped prevent child marriages and promoted higher education for girls.

The key objectives of the programme is to provide academic, material and social support that allow a girl child to access quality education, attend school with dignity and reduce the chances of her dropping out.

We supported the education of 13,000 girl children during the year under this programme.

Project Unnati

In today's scenario, where digital learning has become as important as literacy itself, we partnered with specialised agencies to provide digital awareness and basic computer education to first generation computer learners between Class VI and Class IX in semi-urban and rural areas. Beyond providing classroom teaching, the sustainability of the project is also ensured by following the 'Training the Trainer' model wherein school teachers are also trained. Additionally, well equipped computer labs are installed at each of these schools where training is imparted, so as to ensure continued practice for students. This programme widened the horizons of education and future employability for these underprivileged children.

The key objective of the programme is to provide exposure to basic computer education.

During the year, we trained 12,000 students under this project.

Project Agastya

Under Project Agastya, Mobile Science Labs (MSL) provide hands-on science learning experience and ignite and inculcate scientific spirit and acumen among government school students. During the year, 28,000 school students were benefitted through 10 mobile science laboratories and one Science Centre.

28,000
Students benefitted through
Project Agastya

Kashmir Super - 30 (Medical)

Project Kashmir Super-30 (Medical) provides mentoring and coaching to talented students from Jammu and Kashmir & Ladakh region in collaboration with the Indian Army for competing in medical entrance exams in India. This residential training program gives wings to academic aspirations of the youth for their career development. The project also aims to provide academic support and conducive environment of learning and growth for students from the Valley.

HP Scholarships

In order to promote conducive academic growth among students from SC, ST, OBC and PWD communities, over 16,900 scholarships were granted.



7

Project Unnati

Corporate Social Responsibility



Healthcare

Providing access to healthcare has been an important goal for the Government of India. However, there are challenges involved in terms of accessibility and affordability. These challenges are more pressing in rural India.

To enhance access to quality healthcare services for individuals, we are working to provide solutions to health, hygiene and sanitation concerns. Our initiatives are aimed at the marginalised and disadvantaged communities. Few of our major initiatives in this focus area are as follows:

Project Dhanwantari

To address the critical situation of health requirements and provide basic medical facilities to people in need in remote rural areas and urban slums, we are collaborating with a specialised implementing agency for operating mobile medical vans. These vans provide basic medical attention to the rural populace and urban slums. Through this partnership, we ensured medical facilities at the doorstep, providing basic treatments for common ailments, health awareness and necessary referrals for major ailments.

The key objective of this project is to provide awareness as well as diagnostic and curative services to the rural community. We provided health facilities through 25 mobile medical vans under this project in various parts of the country.

Project Suraksha

Long Distance Truckers (LDT) are among the high-risk category for AIDS as identified by the National Aids Control Organisation and this very target group is one of the most vulnerable stakeholders in our supply chain. Therefore, our intervention through the Khushi Clinics set up at various retail outlets on the highways has been an obvious and rational engagement for us. Besides providing basic medical facilities, which are scanty on the highways, the clinics also extend AIDS awareness, STI treatment, social marketing of contraceptives and counselling, among others to ensure the health and well-being of the truckers.

The key objectives of the programme are to encourage adoption of safer sexual behaviour and practices by the truckers, promote the use of contraceptives, diagnosis and treatment of STIs at the Khushi Clinics.

Under this project, seven clinics were operationalised to increase awareness on HIV/AIDS among truckers.

Project Dil without Bill

We aim to save lives by providing free of cost heart surgeries to the less privileged and economically marginalised sections who are unable to afford such expensive medical procedures or would have inevitably incurred of heavy financial debt. Awareness and follow-up camps conducted at various cities and

towns, during the year is also an initiative to reach out to the most needy patients.

The key objective is to provide financial assistance towards heart surgery to socially and economically backward people.

During the year, we supported 600 heart surgeries

HPCL has come forward and strengthened its commitment to the Indian Army by extending help to paralysed soldiers and family members.

Under the CSR project, we provided mobility equipment like motorised wheelchair and modified auto two wheelers. These equipment will facilitate greater freedom of mobility to the beneficiaries.



Skill Development

India has one the biggest advantages in the form of a demographic dividend, a key driver for future growth. It is important to equip our younger generation with relevant skills and tools to grow as responsible individuals and contribute to the nation's growth.

There are significant efforts required to equip the personnel with relevant skills in terms of infrastructure and collaboration with local partners while understanding the regional and socio-economic nuances. To achieve this, HPCL has partnered with a specialised agency for implementation of a project envisioned under Skill India Mission through skill training and development of youth across the country.

Project Swavalamban

Different locations have diverse labour demands and needs depending on opportunities like infrastructure and industries available in the area. It is in line with these demand-based needs that training in diverse trades like electrical, welding, hospitality, driving, tailoring, beautician course, among others are identified and imparted to the underprivileged youth in these areas through our Swavalamban programme. The module also provides capacity building and soft skills required for these youth to sustain employment and earn a livelihood for themselves and their family.

The key objective is to provide training and encourage skills development for potential candidates from the underprivileged sections and enable them to earn a livelihood. During the year, training on various skills was provided to 2,000 youths under the project.

Contributions to Skill Development Institutes (SDIs)

The Skill Development Institutes (SDIs) are conceptualised by the Government of India and operationalised by Oil & Gas CPSEs with a special focus on imparting skills in industry-oriented trades to enhance employability and bridge the skill gap of the nation. This year, we contributed to the construction of SDI Bhubaneswar main campus.

In line with the Government of India's National Skill Development Mission, we are operating an SDI in Visakhapatnam since October, 2016 to train unemployed youth in vocational trades from different sectors, including Hydrocarbon related job roles.

The year at SDI, Visakhapatnam:

- Imparted training to 11,118 candidates with 75% placement during the last three-and-a-half years
- Carried out special projects inside Rajahmundry and Visakhapatnam prisons and trained over 650 inmates in three trades viz. welding, plumbing, jute bag stitching, impacting 1,400 lives positively during the last three years
- Conducted training on domestic LPG installation and safety for women covering 93 trainees from OMCs in three batches
- Conducted the first ever training for foreign nationals (Bhutan) in Petrol Pump Operations. We are setting up retail outlets in Bhutan in association with the State Trading Corporation of Bhutan Ltd.
- Obtained National Skill Development Corporation (NSDC) accreditations for seven skill training centres
- Inaugurated the first ever retail centre of excellence for skill training of Retail Sales Associates
- Partnered with Visakha District Police (Rural) to skill unemployed tribal youth from the agency areas of Visakhapatnam district as part of our community policing initiative 'Prerana', through which over 200 unemployed tribal youth have been trained till date
- Carried out Swachhta Pakhwada campaigns, involving trainees, faculty members and other staff of the Institute and received appreciation from national and international forums in the form of awards and citations



Promoting Sports

Annual Inter School Athletic Championship - 2020, a flagship event created a milestone by introducing a Global Live Webcast of the event. The 14th edition of the event was conducted during January 2020. This edition witnessed maximum participation with 2,000 students from 92 schools, including students from Municipal/Government aided schools taking

part in the event. The event was graced by eminent personalities who inspired the young students with anecdotes from the life.



Environment and Community Development

Environment conservation is the building block for a sustainable ecosystem. We are focused on this area and have undertaken interventions towards sustainable development.

Swachh Bharat Abhiyan

We contributed to the national cause of Swachh Bharat Abhiyan by developing sanitation infrastructure and sensitising communities. Our employees and stakeholders participated in the mass-movement on cleanliness and hygiene. Following are the key activities undertaken:

- Construction or upgradation of over 1,000 toilets in schools and communities
- Contribution made towards welfare of sanitation workers engaged in Kumbh Mela 2019, Prayagraj
- Swachhta Pakhwada and Swachhta Hi Sewa campaigns were observed with over one Lakh awareness activities to sensitise the masses on cleanliness and hygiene across the country. These campaigns focused on involvement and participation of school students, dealers, distributors, suppliers, communities, women and youth
- Over 3,200 plastic collection points set up at various locations, including retail outlets, and campaigns were undertaken to spread the message on eliminating single-use plastic
- Over three Lakh school students sensitised under 'Plastic-Free Ranchi' campaign
- Beach cleaning activities carried out at various parts of the country for collection and proper disposal of waste
- Manhole cleaning robot, 'Bandicoot 2.0' was provided to the Coimbatore City Municipal Corporation to eliminate manual scavenging
- Swachhta drives undertaken this year at Swachh Iconic Place (SIP) Golden Temple, Amritsar with massive participation from citizens in unique initiatives like plogging, waste collection drives, walkathon, among other activities
- Collaboration with All India Radio (AIR) and local FM Radio Channels to spread the message of Swachhta, association with Indian Railways, public transport services and cleanliness drives in public places with high footfall

Corporate Social Responsibility

- Built community toilet blocks in the city under Open Defecation Free (ODF) project with the Municipal Corporation of Amritsar
- 'Swatantrata Ke Rang, Swachhta Ke Sang' programme organised on August 15, 2019 with superlative cultural performances by specially abled artists



Employee Volunteering

We encourage employee and stakeholder participation and promote inclusiveness through volunteering in activities or involvement in projects aimed at nation building, social empowerment, upliftment of various disadvantaged sections of the society, capacity building, besides health and environment initiatives.

HP Sampark, Ek Prayaas

HP SAMPARK has emerged as a vibrant platform that kindles, nurtures and channelises the volunteering spirit at HPCL and amplifies outcomes by bringing smiles and touching lives. It is an employee volunteering programme aligned with the corporation's values, vision and culture. It provides employees with a platform to drive HPCL's vision by volunteering for social causes and adding strategic value to the business. The aim is to provide our employees with opportunities and options to make a difference in the lives of people who are not so privileged by providing a platform wherein employees or their families can consolidate their volunteering efforts for bringing a positive change in society.

HP Sampark Volunteering Initiatives 2019-20

- **Mini Paralympics:** Organised Mini Paralympics for children from 16 orphanages, and specially abled young adults from several NGOs with different disabilities also participated in these games
- **Annual Monsoon Car Rally:** Organised a 140-km rally for employees and their family to a school for children with hearing impairment and speech deficiency. Our volunteers participated in painting the school building, planting trees and distribution of school kits to school children. They also provided audiometry machines, water purifiers, and music system to the school
- **Winter Donations:** Our North Zone distributed blankets to the poor and needy during the winter through voluntary contributions from employees
- **Women's Day:** Supported HP Shakti Ladies Club with Women's Day programmes. All nine Shakti Ladies Clubs initiated activities for specially abled children. This year's theme was bringing smiles to the faces of visually challenged children and adults. Support was extended in identifying NGOs wherever required and each club celebrated Women's Day in special ways.

- **Daan Utsav:** On Gandhi Jayanti, our zonal employees across India celebrated 'Joy of Giving Day' with special beneficiaries through voluntary contributions. Movie screening was arranged for children from orphanages, Cancer Patient Aid Association, Make a Wish Foundation, Thalassemia patients and senior citizens from old-age homes.
- **Khushiyon Ka Recycle:** Organised collection of reusable items in six cities. In housing colonies, HP Shakti members coordinated activities for the noble cause. Clothes were also distributed to the workers, security staff, and the contract and housing workforce as a part of the initiative.
- **Blood Donation Camps:** Arranged several blood donation camps at various locations across India on the occasion of Foundation Day of the Corporation.

HP Shakti Club

HP Shakti Club is an endeavour to provide a platform to women employees and female family members to get together and create a new, active, supportive and comfortable arena exclusively for the ladies to address their problems, explore social connections, foster friendships, share joyful moments and give back to the society through philanthropic and social initiatives.

There are nine active Shakti Clubs across the country. These clubs conducted over 90 activities during the year to support the society and bring change by undertaking various initiatives like awareness sessions for underprivileged kids, visit to old-age homes, supporting specially-abled kids, organising fundraiser, among others.



Pradhan Mantri Ujjwala Yojana (PMUY)

Pradhan Mantri Ujjwala Yojana was launched by the Hon'ble Prime Minister Shri Narendra Modi on May 1, 2016 in Balia, Uttar Pradesh. It aims to safeguard the health of women and children by providing them with clean cooking fuel - LPG, so that they don't have to compromise their health in smoky kitchens or wander in unsafe areas collecting firewood.

During the year, HPCL provided 19.56 Lakh low income households LPG Connections under PMUY.

19.56 Lakh
Connections provided to low
income households under PMUY



Notable Projects

- We participated in the 17th edition of Tata Mumbai Marathon for the 7th consecutive year in the Champions with Disability Category wherein our employees served as buddies for special children at ADAPT and pushed their wheelchairs. Over 250 employees ran in various endurance categories
- Contribution to the Armed Forces Flag Day Fund for the welfare of our honourable ex-servicemen, war widows and their dependents
- In order to help the restoration activities in the state of Odisha after the devastating Cyclone 'Fani', HPCL made contribution to Odisha State Disaster Management Authority (OSDMA)



Investment in CSR Projects

We have reached out to the marginalised through innovative, value-driven and well-designed CSR projects that bring together collective effort to positively impact lives.

During the reporting year, the Corporation spent ₹182.24 Crore in the implementation of various CSR initiatives creating social capital, especially in the host communities of the business.

Expense Areas	(₹ Crore)
Promoting Education	39.58
Promoting Health Care	25.03
Empowerment of Socially and Economically Backward Groups	6.64
Promotion of Nationally Recognised and Para-Olympic Sports	0.88
Imparting Employment by Enhancing Vocational Skills	41.27
Swachh Bharat Abhiyaan	27.22
Environment Sustainability	36.80
Others	4.82
Total	182.24

Project AAKANKSHA

The main objective of this project is to help students from rural areas to dream of a better future for themselves and work towards inclusion in the mainstream of the society. Through this project various activities were undertaken by our zonal and location level teams, such as:

- Educational tours to places of prominence
- Screening of inspirational movies
- Installation of water cooler, RO, distribution of benches and school kits, among others
- Imparting better education by donating computers and projectors to schools
- Provision of washbasins with soap and hand sanitisers as part of 'Break the chain C', a COVID-19 prevention campaign
- Aiding in construction of compound wall at government school
- Installation of various academic infrastructure and facilities at government schools and libraries
- Distribution of steel meal plates
- Donation of medical equipment
- Donation to Karnataka Flood Relief operations
- Construction of classrooms and toilet blocks
- Tree plantation drive
- Distribution of hygiene kits to school students

Total Expenditure on CSR

(₹ Crore)

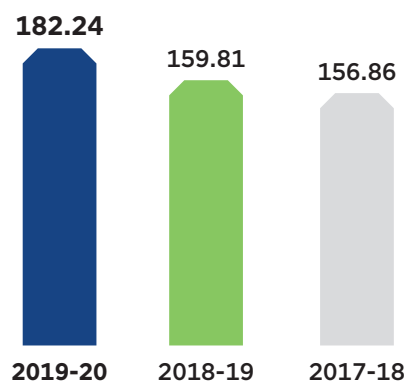

ALIGNMENT OF OUR BUSINESS PRACTICES TO THE SUSTAINABLE DEVELOPMENT GOALS

Goal No.	Sustainable Development Goal	Page No.
	End poverty in all its forms everywhere	50-53,116-121
	End hunger, achieve food security and improved nutrition and promote sustainable agriculture	116-117
	Ensure healthy lives and promote well-being for all at all ages	99-100,116-121
	Ensure inclusive and equitable quality education and promote life-long learning opportunities for all	82-86,116-117
	Achieve gender equality and empower all women and girls	81,92-93,116-117
	Ensure availability and sustainable management of water and sanitation for all	69-71
	Ensure access to affordable, reliable, sustainable and modern energy for all	12-21,68,120
	Promote sustained, inclusive and sustainable economic growth, full and productive employment and decent work for all	50-55,88-93,99-101
	Build resilient infrastructure, promote inclusive and sustainable industrialisation and foster innovation	12-21,50-51,105-107

Goal No.	Sustainable Development Goal	Page No.
	Reduce inequality within and among countries	116-121
	Make cities and human settlements inclusive, safe, resilient and sustainable	74,116-121
	Ensure sustainable consumption and production patterns	58-75,105-107
	Take urgent action to combat climate change and its impacts	58-75,105-107,120
	Conserve and sustainably use the oceans, seas and marine resources for sustainable development	69-71
	Protect, restore and promote sustainable use of terrestrial ecosystems, sustainably manage forests, combat desertification, and halt and reverse land degradation and halt biodiversity loss	66,74-75
	Promote peaceful and inclusive societies for sustainable development, provide access to justice for all and build effective, accountable and inclusive institutions at all levels	23-29,92-93
	Strengthen the means of implementation and revitalise the global partnership for sustainable development	31,66,105-107,116-121

INDIA'S NATIONALLY DETERMINED CONTRIBUTIONS

Goal No.	Nationally Determined Contribution	Page No.
1	Sustainable Way of Living	22-23,38-39,58,114-115,120
2	Climate Friendly and Cleaner Path to Economic Development	58-75,105-107,119-120
3	Reducing Emissions Intensity of GDP by 33- 35%	64-68
4	40% Cumulative Electric Power Installed Capacity from Non-fossil Fuel based Energy Resources by 2030	68
5	Creation of Additional Carbon Sink of 2.5-3 BTCO ₂ e	66
6	Better Adaptation to Climate Change	58-75,105-107,119-120
8	Building Capacities for Diffusing Cutting-edge Climate Technology	64-68,105-107

*Note: INDCs as applicable

UNGC PRINCIPLES

UNGC Principle	Category	Description	Page No.
1	Human Rights	Businesses should support and respect the protection of internationally proclaimed human rights	92-93
2	Human Rights	Businesses should make sure that they are not complicit in human rights abuses	92-93
3	Labour	Businesses should uphold the freedom of association and the effective recognition of the right to collective bargaining	92-93
4	Labour	Businesses should uphold the elimination of all forms of forced and compulsory labour	92-93
5	Labour	Businesses should uphold the effective abolition of child labour	92-93
6	Labour	Businesses should uphold the elimination of discrimination in respect of employment and occupation	81,92-93
7	Environment	Businesses should support a precautionary approach to environmental challenges	58-75
8	Environment	Businesses should undertake initiatives to promote greater environmental responsibility	58-75
9	Environment	Businesses should encourage the development and diffusion of environmentally friendly technologies	58-75
10	Anti-Corruption	Businesses should work against corruption in all its forms, including extortion and bribery	23-29

INDEPENDENT ASSURANCE STATEMENT



Introduction and objectives of work

BUREAU VERITAS has been engaged by **Hindustan Petroleum Corporation Ltd. (HPCL)** to conduct an independent assurance of its **Sustainability Report** for the year **2019-20**. This Assurance Statement applies to the related information included within the scope of work described below.

This information and its presentation in the **Sustainability Report 2019-20** are the sole responsibility of the management of HPCL. Bureau Veritas was not involved in the drafting of the Report. Our sole responsibility was to provide independent assurance on its content.

Scope of work

The assurance process was conducted in line with the requirements of the Assurance Standard **AA1000AS 2008 (with 2018 addendum)** Type 2 assurance. The scope of work included:

- Data and information included in Sustainability Report 2019-20 for the **reporting period 1st April 2019 to 31st March 2020**;
- Appropriateness and robustness of underlying reporting systems and processes, used to collect, analyse and review the information reported;
- Evaluation of the Report against the main principles of the AA1000 Assurance Standard (2008)¹
 - Inclusivity
 - Materiality
 - Responsiveness
 - Impact
- Evaluation of the Report against the principles of Accuracy, Accessibility, Balance, Clarity, Comparability, Reliability, Timeliness and Stakeholder Inclusiveness, as defined in the GRI Sustainability Reporting Standards² “In accordance-Comprehensive”;

The level of assurance has been applied as **“Moderate”** for all sections of the report.

Methodology

As part of its independent assurance, Bureau Veritas undertook the following activities:

1. Audit was done remotely through video conferencing at below locations of HPCL and interviewed relevant management personnel of HPCL.
 - LPG Plant, Bhopal
 - Autocare Centre, Bandra Kurla Complex, Mumbai
 - Pipelines, VVSPL- Visakh Dispatch Station
 - Mumbai Refinery
 - Miraj IRD
 - Mazgaon Lubes Plant
 - Aviation Service Facility, Calicut
2. Site visit was done for following location of HPCL and interviewed relevant management personnel of HPCL.
 - Corporate HSE Dept., Mumbai

¹ Published by Accountability: The Institute of Social and Ethical Accountability <http://www.accountability.org.uk> (AA 1000 AS 2008 is the latest version of the assurance standard with 2018 addendum)

² GRI Standards are published by the Global Reporting Initiative, P.O. Box 10039, 1001 EA, Amsterdam, The Netherlands and can be downloaded from the GRI web site www.globalreporting.org

We interviewed Plant Operations & Maintenance, Health, Safety & Environment managers remotely through video conferencing at above mentioned seven sites and also the Sustainability team of HPCL at Corporate HSE department through site visit:

3. HPCL had submitted performance data on reported disclosures of GRI standard topics. The data management at the above locations was assessed by Bureau Veritas.
4. The data management systems and procedures were assessed on a sampling basis. Data on various GRI standard disclosures was verified.
5. Bureau Veritas reviewed stakeholder engagement activities that had been undertaken by HPCL as a part of its stakeholder engagement process. Various records of the stakeholder engagement activities were reviewed to confirm how topics material to HPCL's stakeholders had been determined.

Our work was conducted against Bureau Veritas' standard procedures and guidelines for external Assurance of Sustainability Reports, based on current best practice in independent assurance.

The work was planned and carried out to provide a **"Moderate"** level of assurance and we believe it provides an appropriate basis for our conclusions.

Our findings

On the basis of our methodology and the activities described above, it is our opinion that:

- Nothing has come to our attention to indicate that the reviewed statements within the scope of our verification are inaccurate and the information included therein is not fairly stated;
- It is our opinion that HPCL has established appropriate systems for the collection, aggregation and analysis of quantitative data such as Environmental, Health & Safety, Human Resource, Labour as well as Product and Investor related data.

Alignment with the principles of AA1000AS (2008)

Inclusivity

HPCL has processes in place for engaging with a range of key stakeholders including socially responsible investors, Government officials, local community representatives and has undertaken stakeholder engagement activities that have served as inputs for its Sustainability report 2019-20, covering a range of topics such as Customer satisfaction, Employee welfare, Supply Chain, Community Welfare and Environment.

Materiality

The Report addresses the range of environmental, social and economic issues of concern that HPCL and its stakeholders have identified as being of highest material importance. The identification of material issues has considered both internal assessments of risks and opportunities to the business, as well as stakeholders' views and concerns. The material issues were identified by a process of stakeholder engagement and interaction and the entire process was conducted through a survey in which the stakeholders were requested to provide their feedback relating to various issues.

Responsiveness

HPCL is responding to those issues it has identified as material and demonstrates this in its policies, objectives, indicators and performance targets. The reported information can be used by the organisation and its stakeholders as a reasonable basis for their opinions and decision-making. The company has taken various initiatives towards delivering environmentally friendly services along with occupational health and safety, appropriate measures for emergency handling, control and risk management in its operations.

Impact

There is no finding from our assessment that HPCL had not monitored, measured or has not been accountable for its actions related to its material topics and their effect on the broader ecosystem

Evaluation against Global Reporting Initiative (GRI) Sustainability Reporting Standards

Bureau Veritas undertook an evaluation of **HPCL Sustainability Report 2019-20** against the GRI Sustainability Reporting Standards 2016. This included cross checking the GRI index table against all the reference documents to provide an opinion on the self-declared GRI reporting option.

Based on our work, it is our opinion that the **Sustainability Report 2019-20** has been prepared in accordance with the **GRI Standards** including appropriate consideration of the Reporting Principles and necessary indicators to meet the requirements of GRI Reporting Option **"In accordance-Comprehensive"**.

Limitations and Exclusions

Excluded from the scope of our work is assurance of any information reported by HPCL relating to:

- Activities outside the defined assurance period stated hereinabove;
- Positional statements (expressions of opinion, belief, aim or future intention) by HPCL and statements of future commitment;
- Competitive claims in the report claiming “first in India”, “first time in India”, “first of its kind”, etc;
- Our assurance does not extend to the activities and operations of HPCL outside India i.e. outside of the scope and geographical boundaries as well as the operations undertaken by any subsidiaries or joint ventures of the Company.
- Our assurance of the economic and financial performance data of HPCL is based only on the audited annual report³ of HPCL for the Financial Year 2019-20 and our conclusions rely solely upon that audited report

This independent statement should not be relied upon to detect all errors, omissions or misstatements that may exist within the Report.

Statement of independence, impartiality and competence

Bureau Veritas is an independent professional services company that specialises in Quality, Health, Safety, Social and Environmental management with almost 180 years history in providing independent assurance services, and an annual turnover in excess of € 4.9 billion.

Bureau Veritas has implemented a Code of Ethics across the business to maintain high ethical standards among staff in their day to day business activities. We are particularly vigilant in the prevention of conflicts of interest.

No member of the assurance team has a business relationship with HPCL, its Directors or Managers beyond that required of this assignment. We have conducted this verification independently, and there has been no conflict of interest.

The assurance team has extensive experience in conducting assurance over environmental, social, ethical and health and safety information, systems and processes and has over 5 years combined experience in this field and an excellent understanding of Bureau Veritas standard methodology for the Assurance of Sustainability Reports.

Bureau Veritas (India) Private Limited

72 Business Park, 9th Floor, MIDC Cross Road ‘C’, Opp. SEEPZ Gate #2, Andheri (East) Mumbai-400 093 India.



Jitendra Kadam
Lead Assuror



Sanjay Patankar
Technical Reviewer

Date: 13-Sep.-2020
Mumbai



³ The Annual Report of HPCL is available for public reference at the web link <http://www.hindustanpetroleum.com/financial> and can be downloaded from that link

GRI CONTENT INDEX

GRI Standard	Ref No.	Status	Disclosure	Page No.	Status of Assurance	Omission		
						Part Omitted	Reason	Explanation
GRI 101: Foundation 2016								
General Disclosures								
GRI 102: General Disclosures 2016	Organisational profile							
	102-1	Mandatory	Name of the organisation	Cover Page	Assured			
	102-2	Mandatory	Activities, brands, products, and services	14-21	Assured			
	102-3	Mandatory	Location of headquarters	Cover Page	Assured			
	102-4	Mandatory	Location of operations	14-21	Assured			
	102-5	Mandatory	Ownership and legal form	12,51	Assured			
	102-6	Mandatory	Markets served	16-21	Assured			
	102-7	Mandatory	Scale of the organisation	12-21,50-53,79	Assured			
	102-8	Mandatory	Information on employees and other workers	79	Assured			
	102-9	Mandatory	Supply chain	30	Assured			
	102-10	Mandatory	Significant changes to the organisation and its supply chain	3,52	Assured			
	102-11	Mandatory	Precautionary Principle or approach	27-29	Assured			
	102-12	Mandatory	External initiatives	3,31	Assured			
	102-13	Mandatory	Membership of associations	31	Assured			
	Strategy							
	102-14	Mandatory	Statement from senior decision-maker	4-9	Assured			
	102-15	Mandatory	Key impacts, risks, and opportunities	27	Assured			
	Ethics and integrity							
	102-16	Mandatory	Values, principles, standards, and norms of behavior	22-23,28-29	Assured			
	102-17	Mandatory	Mechanisms for advice and concerns about ethics	29	Assured			
	Governance							
	102-18	Mandatory	Governance structure	23-29	Assured			
	102-19	Mandatory	Delegating authority	27	Assured			
	102-20	Mandatory	Executive-level responsibility for economic, environmental, and social topics	23-25,39	Assured			
	102-21	Mandatory	Consulting stakeholders on economic, environmental, and social topics	40-47	Assured			
	102-22	Mandatory	Composition of the highest governance body and its committees	23-25	Assured			
	102-23	Mandatory	Chair of the highest governance body	23-25	Assured			
	102-24	Mandatory	Nominating and selecting the highest governance body	23	Assured			
	102-25	Mandatory	Conflicts of interest	28	Assured			
	102-26	Mandatory	Role of highest governance body in setting purpose, values, and strategy	23-25,39	Assured			
	102-27	Mandatory	Collective knowledge of highest governance body	23	Assured			
	102-28	Mandatory	Evaluating the highest governance body's performance	23	Assured			
102-29	Mandatory	Identifying and managing economic, environmental, and social impacts	23-25,40-47	Assured				
102-30	Mandatory	Effectiveness of risk management processes	27	Assured				
102-31	Mandatory	Review of economic, environmental, and social topics	46-47	Assured				
102-32	Mandatory	Highest governance body's role in sustainability reporting	39	Assured				

GRI Standard	Ref No.	Status	Disclosure	Page No.	Status of Assurance	Omission		
						Part Omitted	Reason	Explanation
GRI 102: General Disclosures 2016	102-33	Mandatory	Communicating critical concerns	39	Assured			
	102-34	Mandatory	Nature and total number of critical concerns	-	Assured		Confidentiality Constraints	Confidential being a business information
	102-35	Mandatory	Remuneration policies	26	Assured			
	102-36	Mandatory	Process for determining remuneration	26	Assured			
	102-37	Mandatory	Stakeholders' involvement in remuneration	26	Assured			
	102-38	Mandatory	Annual total compensation ratio	26	Assured			
	102-39	Mandatory	Percentage increase in annual total compensation ratio	26	Assured			
	Stakeholder engagement							
	102-40	Mandatory	List of stakeholder groups	41	Assured			
	102-41	Mandatory	Collective bargaining agreements	93	Assured			
	102-42	Mandatory	Identifying and selecting stakeholders	40-41	Assured			
	102-43	Mandatory	Approach to stakeholder engagement	40-45	Assured			
	102-44	Mandatory	Key topics and concerns raised	42-47	Assured			
	Reporting practice							
	102-45	Mandatory	Entities included in the consolidated financial statements	3	Assured			
	102-46	Mandatory	Defining report content and topic Boundaries	3,47	Assured			
	102-47	Mandatory	List of material topics	47	Assured			
	102-48	Mandatory	Restatements of information	65	Assured			
	102-49	Mandatory	Changes in reporting	3	Assured			
	102-50	Mandatory	Reporting period	3	Assured			
	102-51	Mandatory	Date of most recent report	3	Assured			
	102-52	Mandatory	Reporting cycle	3	Assured			
	102-53	Mandatory	Contact point for questions regarding the report	3	Assured			
	102-54	Mandatory	Claims of reporting in accordance with the GRI Standards	3	Assured			
	102-55	Mandatory	GRI content index	128-132	Assured			
	102-56	Mandatory	External assurance	125-127	Assured			
Material Topics								
GRI 200 Economic Standard Series								
Anti-corruption								
GRI 103: Management Approach 2016	103-1	Material	Explanation of the material topic and its Boundary	46-47	Assured			
	103-2	Material	The management approach and its components	23-29	Assured			
	103-3	Material	Evaluation of the management approach	23-29	Assured			
GRI 205: Anti-corruption 2016	205-1	Material	Operations assessed for risks related to corruption	27-29	Assured			
	205-2	Material	Communication and training about anti-corruption policies and procedures	27-29	Assured			
	205-3	Material	Confirmed incidents of corruption and actions taken	28	Assured			

GRI Content Index

GRI Standard	Ref No.	Status	Disclosure	Page No.	Status of Assurance	Omission		
						Part Omitted	Reason	Explanation
Anti-competitive Behavior								
GRI 103: Management Approach 2016	103-1	Material	Explanation of the material topic and its Boundary	46-47	Assured			
	103-2	Material	The management approach and its components	104	Assured			
	103-3	Material	Evaluation of the management approach	104	Assured			
GRI 206: Anti-competitive Behavior 2016	206-1	Material	Legal actions for anti-competitive behavior, anti-trust, and monopoly practices	104	Assured			
GRI 300 Environmental Standards Series								
Energy								
GRI 103: Management Approach 2016	103-1	Material	Explanation of the material topic and its Boundary	46-47	Assured			
	103-2	Material	The management approach and its components	61	Assured			
	103-3	Material	Evaluation of the management approach	61	Assured			
GRI 302: Energy 2016	302-1	Material	Energy consumption within the organisation	61	Assured			
	302-2	Material	Energy consumption outside of the organisation	61	Assured			
	302-3	Material	Energy intensity	62-63	Assured			
	302-4	Material	Reduction of energy consumption	62-63	Assured			
	302-5	Material	Reductions in energy requirements of products and services	106-107	Assured			
Water								
GRI 103: Management Approach 2016	103-1	Material	Explanation of the material topic and its Boundary	46-47	Assured			
	103-2	Material	The management approach and its components	69	Assured			
	103-3	Material	Evaluation of the management approach	69	Assured			
GRI 303: Water 2016	303-1	Material	Water withdrawal by source	69	Assured			
	303-2	Material	Water sources significantly affected by withdrawal of water	69	Assured			
	303-3	Material	Water recycled and reused	70	Assured			
Emissions								
GRI 103: Management Approach 2016	103-1	Material	Explanation of the material topic and its Boundary	46-47	Assured			
	103-2	Material	The management approach and its components	64	Assured			
	103-3	Material	Evaluation of the management approach	64	Assured			
GRI 305: Emissions 2016	305-1	Material	Direct (Scope 1) GHG emissions	64	Assured			
	305-2	Material	Energy indirect (Scope 2) GHG emissions	64	Assured			
	305-3	Material	Other indirect (Scope 3) GHG emissions	65	Assured			
	305-4	Material	GHG emissions intensity	65	Assured			
	305-5	Material	Reduction of GHG emissions	64-65	Assured			
	305-6	Material	Emissions of ozone-depleting substances (ODS)	60	Assured			
	305-7	Material	Nitrogen oxides (NOX), sulfur oxides (SOX), and other significant air emissions	65	Assured			

GRI Standard	Ref No.	Status	Disclosure	Page No.	Status of Assurance	Omission		
						Part Omitted	Reason	Explanation
Effluents and Waste								
GRI 103: Management Approach 2016	103-1	Material	Explanation of the material topic and its Boundary	46-47	Assured			
	103-2	Material	The management approach and its components	69,72	Assured			
	103-3	Material	Evaluation of the management approach	69,72	Assured			
GRI 306: Effluents and Waste 2016	306-1	Material	Water discharge by quality and destination	69	Assured			
	306-2	Material	Waste by type and disposal method	72	Assured			
	306-3	Material	Significant spills	69	Assured			
	306-4	Material	Transport of hazardous waste	72	Assured			
	306-5	Material	Water bodies affected by water discharges and/or runoff	69	Assured			
Environmental Compliance								
GRI 103: Management Approach 2016	103-1	Material	Explanation of the material topic and its Boundary	46-47	Assured			
	103-2	Material	The management approach and its components	58-59	Assured			
	103-3	Material	Evaluation of the management approach	58-59	Assured			
GRI 307: Environmental Compliance 2016	307-1	Material	Non-compliance with environmental laws and regulations	73	Assured			
GRI 400 Social Standards Series								
Occupational Health and Safety								
GRI 103: Management Approach 2016	103-1	Material	Explanation of the material topic and its Boundary	46-47	Assured			
	103-2	Material	The management approach and its components	94,99	Assured			
	103-3	Material	Evaluation of the management approach	94,99	Assured			
GRI 403: Occupational Health and Safety 2016	403-1	Material	Workers representation in formal joint management-worker health and safety committees	95	Assured			
	403-2	Material	Types of injury and rates of injury, occupational diseases, lost days, and absenteeism, and number of work-related fatalities	95	Assured			
	403-3	Material	Workers with high incidence or high risk of diseases related to their occupation	95	Assured			
	403-4	Material	Health and safety topics covered in formal agreements with trade unions	93	Assured			
Customer Health and Safety								
GRI 103: Management Approach 2016	103-1	Material	Explanation of the material topic and its Boundary	46-47	Assured			
	103-2	Material	The management approach and its components	104	Assured			
	103-3	Material	Evaluation of the management approach	104	Assured			
GRI 416: Customer Health and Safety 2016	416-1	Material	Assessment of the health and safety impacts of product and service categories	104	Assured			
	416-2	Material	Incidents of non-compliance concerning the health and safety impacts of products and services	111	Assured			

GRI Content Index

GRI Standard	Ref No.	Status	Disclosure	Page No.	Status of Assurance	Omission		
						Part Omitted	Reason	Explanation
Marketing and Labeling								
GRI 103: Management Approach 2016	103-1	Material	Explanation of the material topic and its Boundary	46-47	Assured			
	103-2	Material	The management approach and its components	104	Assured			
	103-3	Material	Evaluation of the management approach	104	Assured			
GRI 417: Marketing and Labeling 2016	417-1	Material	Requirements for product and service information and labeling	104	Assured			
	417-2	Material	Incidents of non-compliance concerning product and service information and labeling	104	Assured			
	417-3	Material	Incidents of non-compliance concerning marketing communications	104	Assured			
Socioeconomic Compliance								
GRI 103: Management Approach 2016	103-1	Material	Explanation of the material topic and its Boundary	46-47	Assured			
	103-2	Material	The management approach and its components	50,114-115	Assured			
	103-3	Material	Evaluation of the management approach	50,114-115	Assured			
GRI 419: Socioeconomic Compliance 2016	419-1	Material	Non-compliance with laws and regulations in the social and economic area	92	Assured			
Oil and Gas Sector Supplement (OGSS - GRI G4)								
GRI G4 OGSS - Oil and Gas Sector Supplement	OG 2	Material	Total amount invested in renewable energy	68	Assured			
	OG 3	Material	Total amount of renewable energy generated by source	68	Assured			
	OG 8	Material	Benzene, Lead and Sulphur content in fuels	67	Assured			
	OG 14	Material	Volume of Biofuels produced and purchased	66	Assured			

ABBREVIATIONS

ALDS	Auto LPG Dispensing Stations
ALPG	Auto Liquefied Petroleum Gas
APC	Advanced Process Control
APPCB	Andhra Pradesh Pollution Control Board
API	Application Program Interface
ASFs	Aviation Service Facilities
BEDP	Basic Engineering Design Packages
BND	Bharatiya Nirdeshak Dravya
C&B	Compensation & Benefits
CAAMS	Continuous Ambient Air Monitoring Station
CBG	Compressed Bio Gas
CCR	Continuous Catalytic Reformer
CDCMS	Centralised Distributor & Consumer Management System
CDP	Career Development Policy
CDU	Crude Distillation Unit
CEMS	Continuous Emission Monitoring System
CFA	Clearing and Forwarding Agents
CFD	Committee of Functional Directors
CGD	City Gas Distribution
CMP	Crisis Management Plan
CNG	Compressed Natural Gas
COAT	Crude to Olefins and Aromatics Technology
COD	Contractor Operated Depot
COLD	Contractor Operated Lube Depot
CPCB	Central Pollution Control Board
CPGRAMS	Centralised Public Grievances Redress and Monitoring System
CPM	Certified Petroleum Manager
CPO	Central Procurement Organisation
CPSEs	Central Public Sector Enterprises
CRM	Customer Relationship Management, Certified Reference Material
CSR	Corporate Social Responsibility
CVC	Central Vigilance Commission
DAK	Dearomatised Kerosene
DCS	Distributed Control System
DHDS-ARU	Diesel Hydrodesulfurization-Aromatics Recovery Unit
DHT	Diesel Hydrotreating Unit
EGP	Education Growth Plan
EQMS	Effluent Quality Monitoring System
ER	Employee Relations
ERP	Enterprise Resource Planning
ESI	Employees' State Insurance
ETP	Effluent Treatment Plant
EV	Electric Vehicle
FCC	Fluidised Catalytic Cracking
FII	Foreign Institutional Investors
FO	Furnace Oil
FY	Fiscal Year
GDP	Gross Domestic Product
GeM	Government e-Marketplace
GHG	Green House Gas

GJ	Gigajoule
GRI	Global Reporting Initiative
GST	Goods and Services Tax
GTG	Gas Turbine Generator
HDPE	High-Density Polyethylene
HFHSD	High Flash High Speed Diesel
HGU	Hydrogen Generation unit
HPCL	Hindustan Petroleum Corporation Limited
HPGRDC	Hindustan Petroleum Green Research & Development Centre
HP-SOW	HP-Safety on Wheels
HQO	Head Quarters Office
HR	Human Resource
HSD	High Speed Diesel
HSE	Health, Safety & Environment
ICC	Internal Complaint Committees
IGBC	Indian Green Building Council
IMM	Integrated Margin Management
IMO	International Maritime Organization
IPCC	Intergovernmental Panel on Climate Change
IRD	Inland Relay Depot
ISO	International Standards Organization
IT	Information Technology
IVRS	Interactive Voice Response System
KPI	Key Performance Indicators
kWh	KiloWatt hour
KYC	Know Your Customer
LED	Light Emitting Diode
LDAR	Leak Detection and Repair
LFA	Leave Fare Assistance
LIMS	Laboratory Information Management System
LPG	Liquefied Petroleum Gas
MBLC	M B Lal Committee
MBN	MMBTU/Barrel/NRGF
MCP	Machine Care Programme
MDPL	Mundra Delhi Pipeline
MERC	Management Employee Relations Committee
MMT	Million Metric Tonne
MMTPA	Million Metric Tonne Per Annum
MoEF&CC	Ministry of Environment, Forest & Climate Change
MoP&NG	Ministry of Petroleum & Natural Gas
MOU	Memorandum of Understanding
MPCB	Maharashtra Pollution Control Board
MPSPL	Mumbai-Pune-Solapur Pipeline
MR	Mumbai Refinery
MREP	Mumbai Refinery Expansion Project
MRPL	Mangalore Refinery and Petrochemicals Ltd.
MS	Motor Spirit
MSEs	Micro and Small Enterprises
MSMEs	Micro, Small and Medium Enterprises
MT	Metric Tonne
MTO	Mineral Turpentine Oil
MW	MegaWatt

Abbreviations

MWp	MegaWatt Peak
NABL	National Accreditation Board for Calibration and Testing Laboratories
NDC	Nationally Determined Contributions
NFCCU	New Fluid Catalytic Cracking Unit
NGT	National Green Tribunal
NRI	Non-Resident Indian
NSCI	National Safety Council of India
OCB	Overseas Corporate Body
OD&E	Operations, Distribution & Engineering
OEM	Original Equipment Manufacturer
OISD	Oil India Safety Directorate
OMC	Oil Marketing Companies
ONGC	Oil and Natural Gas Corporation
PAT	Perform, Achieve and Trade
PDA	Propane De-Asphalting
PDS	Pre-desulphurisation Section
PLC	Programmable Logic Controller
PM	Performance Management
PME	Periodical Medical Examination
PMUY	Pradhan Mantri Ujjwala Yojana
PSA	Pressure Swing Adsorption
PSPB	Petroleum Sports Promotion Board
PSU	Public Sector Undertakings
PV	Photo Voltaic
PWD	Persons with Disabilities
QA	Quality Assurance
QC	Quality Control
QR	Quick Response
R&D	Research & Development
REC	Renewable Energy Certificate

RLNG	Regasified Liquefied Natural Gas
RMSC	Risk Management Steering Committee
RON	Research Octane Number
ROU	Right of Use
RTI	Right to Information
RXIL	Receivables Exchange of India Ltd
SBU	Strategic Business Unit
SDG	Sustainable Development Goals
SDI	Skill Development Institute
SEBI	Securities and Exchange Board of India
SEU	Solvent Extraction Unit
SHC	Slurry Hydrocracking
SOx	Sulphur Oxides
SPCB	State Pollution Control Board
SPM	Suspended Particulate Matter
SRFT	Standard Refinery Fuel Tonnage
STP	Sewage Treatment Plant
tCO ₂ e	Tonnes of Carbon Dioxide Equivalent
TDD	Technology Design Document
TDS	Tax Deducted at Source
TDT	Target Delivery Time
TKL	Thousand Kilo Litre
TMT	Thousand Metric Tonnes
TReDS	Trade Receivables Discounting System
UNGC	United Nations Global Compact
VR	Visakh Refinery
VRMP	Visakh Refinery Modernisation Project
VRS	Vapour Recovery System
VTS	Vehicle Tracking System
VVSPL	Visakh Vijayawada Secunderabad Pipeline
WIPS	Women in Public Sector



Sustainability Report 2019-20

Feedback Form

Your feedback is important for continuously improving our Sustainability performance and reporting. Please take a few minutes to answer the following questions:

- How would you rate the overall report quality?
 Excellent Good Average Poor
- Which aspect/(s) did you like the most in the report?
 Coverage of topics Design & Layout Data Representation Readability
- Which section/(s) did you like the most in the report?
 About HPCL Embedded Sustainability Economic Performance
 Environmental Performance People Performance
 Delighting the Customer Corporate Social Responsibility
- What additional information would you like to see in our future reports?

- Any other comments/suggestions?

Kindly provide us your contact information for further correspondence:

Which of the following best describes your occupation/industry?

- Academia Corporation Customer Financial Analyst
 Government Media NGO Shareholder
 Others, please specify

Name: _____ Company: _____

Address: _____

Phone: _____ Email: _____

Mail your responses to:

Sustainability Division - Corporate HSE
Hindustan Petroleum Corporation Ltd.
Mumbai Refinery, Lube Admin Building
B D Patil Marg, Chembur, Mumbai - 400 074
Email ID: corporatsehse@mail.hpcl.co.in

Online Feedback can be given at:
<https://hindustanpetroleum.com>



सत्यमेव जयते

भारत सरकार

मंत्रिमंडल सचिवालय लोक शिकायत निदेशालय

क्या आप अनसूलझी शिकायतों से परेशान हैं ?

आप लोक शिकायत निदेशालय के कार्य क्षेत्र के अंतर्गत मंत्रालयों/विभागों और संगठनों से संबंधित शिकायतों के समाधान के लिए लोक शिकायत निदेशालय की सहायता ले सकते हैं। पिछले कुछ सालों में, इस निदेशालय द्वारा उठाई गई लगभग नब्बे प्रतिशत शिकायतों का संतोषजनक समाधान किया गया है।

अपनी शिकायत दर्ज कराने से पहले कृपया नीचे दी गई शर्तों को ध्यानपूर्वक पढ़ें:-

- आपने अपनी शिकायतों को सम्बन्धित विभाग के समक्ष समाधान हेतु प्रस्तुत कर लिया हो।
- आपकी शिकायत सेवा मामले (रोच्युटी,जीपीएफ इत्यादि जैसे सेवांत हितलाभों के भुगतान के अलावा) संबंधित विभाग के मंत्री के स्तर पर निपटाए गए मामले, वाणिज्यिक अनुबंध, न्यायाधीन मामले, ऐसे मामले जहां निर्णय लेने के लिए अर्द्धन्यायिक पद्धति और अपीलिय प्रक्रियाएं निर्धारित की गई हैं, आरटीआई मामले, धार्मिक मामले से संबंधित न हो।
- किसी भी प्रकार के सुझाव को शिकायत रूप में नहीं माना जाएगा।

लोक शिकायत निदेशालय के कार्यक्षेत्र के अंतर्गत आने वाले मंत्रालयों/ विभागों/संगठनों की सूची

(क)	रेल मंत्रालय	(ज)	सार्वजनिक क्षेत्र के बैंक
(ख)	डाक विभाग	(झ)	सार्वजनिक क्षेत्रों की बीमा कंपनियां
(ग)	बीएसएनएल और एमटीएनएल सहित दूरसंचार विभाग	(त्र)	वित्त मंत्रालय की राष्ट्रीय बचत स्कीम
(घ)	दिल्ली विकास प्राधिकरण, भूमि और विकास कार्यालय, सीपीडब्ल्यूडी और सम्पदा निदेशालय सहित शहरी विकास मंत्रालय	(ट)	श्रम और रोजगार मंत्रालय के अंतर्गत कर्मचारी राज्य बीमा निगम नियंत्रित ईएसआई अस्पताल और औषधालय
		(ठ)	कर्मचारी भविष्य निधि संगठन
(ड)	पेट्रोलियम और प्राकृतिक गैस मंत्रालय, इसके सार्वजनिक क्षेत्र के उपक्रम सहित	(ड)	विदेश मंत्रालय के अंतर्गत क्षेत्रीय पासपोर्ट प्राधिकरण
(च)	भारतीय विमानपतन प्राधिकरण और एअर इंडिया सहित नागर विमानन मंत्रालय	(ढ)	स्वास्थ्य और परिवार कल्याण मंत्रालय के अंतर्गत केंद्रीय सरकार स्वास्थ्य योजना
(छ)	केंद्रीय माध्यमिक शिक्षा बोर्ड, केंद्रीय विद्यालय संगठन, राष्ट्रीय मुक्त विद्यालयीय संस्थान, नवोदय विद्यालय समिति, केंद्रीय विश्वविद्यालय समविश्व-विद्यालय(केंद्रीय) और मानव संसाधन विकास मंत्रालय की छात्रवृत्ति स्कीमें।	(ण)	पर्यटन मंत्रालय
		(त)	युवक कार्यक्रम मंत्रालय
		(थ)	पोत परिवहन, सड़क परिवहन और राजमार्ग मंत्रालय

नोट: आप हमारी वेबसाइट
<http://dpg.gov.in> पर
अपनी शिकायत दर्ज कर सकते हैं।
आप अपनी शिकायत, संपूर्ण सूचना
और संगत दस्तावेजों के साथ
हमें डाक/फैक्स
या ईमेल द्वारा भेज सकते हैं।

हमसे यहां संपर्क करें:-
सचिव
लोक शिकायत निदेशालय
दूसरा तल, सरदार पटेल भवन, संसद मार्ग, नई दिल्ली- 110001
दूरभाष : 011-23743139, 011-23741228, 011-23363733
फैक्स : 011-23345637
वेबसाइट : <http://dpg.gov.in>



सत्यमेव जयते

GOVERNMENT OF INDIA

CABINET SECRETARIAT DIRECTORATE OF PUBLIC GRIEVANCES

Unresolved Grievances Bothering You ?

You may seek help of Directorate of Public Grievances [DPG] in resolution of Grievances relating to Ministries / Departments and Organizations under its Purview. In last few years, nearly ninety percent of the grievances taken up by the Directorate have been resolved favourably.

Please read carefully the conditions listed below before lodging your grievance :

- You should have exhausted the Departmental remedies for individual grievances
- Your grievance should not relate to service matter [other than payment of terminal benefits like gratuity, GPF etc.], a case disposed off at the level of Minister of the concerned Department, commercial contract, a subjudice case, a case where quasi-judicial procedures and appellate mechanisms are prescribed for decision making, RTI matter, Religious matter.
- Suggestion of any sort will not be treated as grievance.

List of Ministries / Departments / Organizations under DPG's purview

[a]	Ministry of Railways	[i]	Public Sector Banks
[b]	Department of Posts	[j]	Public Sector Insurance Companies
[c]	Department of Telecommunications including BSNL and MTNL	[k]	National Saving Scheme of Ministry of Finance
[d]	Ministry of Urban Development including Delhi Development Authority, Land & Development Office, SPWD and Directorate of Estates	[l]	ESI Hospitals and Dispensaries directly controlled by Employees State Insurance Corporation under Ministry of Labour and Employment
[e]	Ministry of Petroleum and Natural Gas including Its Public Sector Undertakings	[m]	Employees' Provident Fund Organization
[f]	Ministry of Civil Aviation including Airports Authority of India and Air India	[n]	Regional Passport Authorities under Ministry of External Affairs
[g]	Ministry of Shipping, Road Transport and Highways	[o]	Central Government Health Scheme under Ministry of Health and Family Welfare
[h]	Ministry of Tourism	[p]	Central Board of Secondary Education, Kendriya Vidyalay Sangathan, National Institute of Open Schooling, Navodaya Vidyalaya Samiti, Central Universities, Deemed Universities [Central] and Scholarship Schemes
		[q]	Ministry of Youth Affairs

Note : You can lodge your Grievance online on our website
<http://dpg.gov.in>.
 You may also send your grievance to us by post or fax with complete information and relevant documents

Contact us at :
 The Secretary
 Directorate of Public Grievances
 2nd Floor, Sardar Patel Bhawan, Sansad Bhawan, New Delhi 100001
 Tel : 011-23743130, 011-23741228, 011-23363733
 Fax : 011-23345637, e-mail : secypg@nic.in
 Website : <http://dpg.gov.in>

SUSTAINABILITY PERFORMANCE 2019-20



Economic

₹2,89,255 Crore
Total Revenue

₹2,637 Crore
Profit After Tax

₹76,133 Crore
Contribution to Exchequer

17.18 MMT
Crude Oil Processing

39.64 MMT
Highest Ever Sales Volume



Environment

25,586 SRFT
Energy Conservation at Refineries

32.6 MWp
Solar Power Capacity

18.6 Crore kWh
Wind Energy Generation

21.2 MMT
Pipeline Throughput

4.96%
Ethanol Blending Achieved



Social

27.52 Million Safe Man-Hours
Best ever safety record at Mumbai Refinery

19.56 Lakh New LPG Connections
Added under the PMUY programme

₹182.24 Crore
Expenditure on CSR Activities

Project Akshayapatra: 20,000
Children provided with mid-day meals across India

Project Nanhi Kali: 13,000
Girl Children Supported from tribal and migrant communities

Project Unnati: 12,000
Students trained with basic computer education



Hindustan Petroleum Corporation Limited

Petroleum House, 17, Jamshedji Tata Road,
Churchgate, Mumbai - 400 020

Visit us at: www.hindustanpetroleum.com | Like us at:  www.facebook.com/hpcl | Follow us at:  www.twitter.com/hpcl